

Date

User name

Responsible

Company stamp

Folding frame wheelchair

Wheelchair measures	
Seat width (LS)	<input type="checkbox"/> 33 <input type="checkbox"/> 36 <input type="checkbox"/> 39 <input type="checkbox"/> 42 <input type="checkbox"/> 45 <input type="checkbox"/> 48
Seat depth (PS)	<input type="checkbox"/> 35 <input type="checkbox"/> 37,5 <input type="checkbox"/> 40 <input type="checkbox"/> 42,5 <input type="checkbox"/> 45 <input type="checkbox"/> 47,5
Footplate distance (DP)	(Real distance between seat and footplate) IMPORTANT NOTICE! From the footplate to the floor minimum 4cm!! (Minimum Front height = DP + 4cm.)
Setting	<input checked="" type="checkbox"/> Standard <input type="checkbox"/> Prudential <input type="checkbox"/> Active <input type="checkbox"/> Extreme
Backrest Height (TS)	Std.Value 36(min 30-max 54)
Crossbrace (black)	<input checked="" type="checkbox"/> Single <input type="checkbox"/> Double(Not seat width 33-36)
Front height	(STD 49) - Rear height

Rear frame	
Aluminium frame	<input checked="" type="checkbox"/> Aluminium standard frame - Same colour of front frame The real seat depth, from the front part of the seat cloth to the backrest tube will be 1 cm more than the declared one. camber <input checked="" type="checkbox"/> 0° <input type="checkbox"/> 1,5° <input type="checkbox"/> 3°
	<input type="checkbox"/> Aluminium frame DYNAMIC 2.0 - (COLOUR: BLACK) 09955 280.00 The real seat depth, from the front part of the seat cloth to the backrest tube will be 1,5 cm more than the declared one. With rake adjustable backrest (±9°) Exclude the installation of : Brake handles for companion (Drum Brake) camber <input checked="" type="checkbox"/> 0° <input type="checkbox"/> 1,5° <input type="checkbox"/> 2° <input type="checkbox"/> 4°
Titanium frame TMAX	<input type="checkbox"/> Front frame + Titanium frame T MAX 06858 550.00 The real seat depth, from the front part of the seat cloth to the backrest tube will be 1 cm more than the declared one. <u>Brushed Titanium frame - not varnished</u> <u>Weight reduction approx. 450gr</u> camber <input checked="" type="checkbox"/> 0° <input type="checkbox"/> 1,5° <input type="checkbox"/> 3°

Front frame	
<input type="checkbox"/> Short frame - Ideal with Seat depth (PS) 35 - 37,5 <input type="checkbox"/> Medium frame - Ideal with Seat depth (PS) 40 - 42,5 <input type="checkbox"/> Long frame - Ideal with Seat depth (PS) 45 - 47,5	Frame Angle <input checked="" type="checkbox"/> 110° <input type="checkbox"/> 100°









Frame colour (aluminium)	
<input checked="" type="checkbox"/> Opaque black <input type="checkbox"/> Polished black (Available until April 2020) <input type="checkbox"/> Bright silver <input type="checkbox"/> Bright anthracite <input type="checkbox"/> Bright blue <input type="checkbox"/> Bright fuchsia <input type="checkbox"/> Bright orange <input type="checkbox"/> Bright lime <input type="checkbox"/> Bright blue china <input type="checkbox"/> Pearl white <input type="checkbox"/> Bright red	





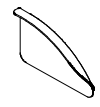

Backrest
<input checked="" type="checkbox"/> Adjustable velcro straps and padded transpiring upholstery

Handle tube
<input checked="" type="checkbox"/> Tubes with standard handle
<input type="checkbox"/> Folding handles  02958 200.00

Colour set: Rear wheels and forks - To be matched only with: Rear wheels Ultra-light Progeo - Standard!		
<input checked="" type="checkbox"/> Polished black	22" 24" 25" 26"	
<input type="checkbox"/> Bright silver	22" 24"	00833 110.00
<input type="checkbox"/> Bright anthracite	24"	00833 110.00
<input type="checkbox"/> Bright orange	22" 24"	00833 110.00
<input type="checkbox"/> Bright fuchsia	22" 24"	00833 110.00
<input type="checkbox"/> Bright blue	22" 24"	00833 110.00
<input type="checkbox"/> Bright red	22" 24"	00833 110.00
<input type="checkbox"/> Bright lime	22" 24"	00833 110.00
<input type="checkbox"/> Pearl white	22" 24"	00833 110.00

Date	Order	User name	Address
Casters			
☆ 5" Soft			
<input type="checkbox"/> 4" Soft			
<input type="checkbox"/> 3" Sport			
<input type="checkbox"/> 6" Soft (Available only with 110° angle)			
<input type="checkbox"/> 6" Pneumatic (Available only with 110° angle)			
<input type="checkbox"/> 7" Soft (Available only with 110° angle)			
<input type="radio"/> 3" Active Soft (wide) (Aluminium alloy rim) 06824 110.00			
<input type="radio"/> 4" Active Sport (narrow) (Aluminium alloy rim) 01398 110.00			
<input type="radio"/> 4" Active Soft (wide) (Aluminium alloy rim) 03943 110.00			
<input type="radio"/> 5" Active Soft (wide) (Aluminium alloy rim) 07518 110.00			
<input type="radio"/> 5" Pneumatic 10844 50.00			
Rear wheels			
☆ 24" Ultra-light Progeo - Standard!			
<input type="checkbox"/> 22" Ultra-light Progeo - Standard!			
<input type="checkbox"/> 25" Ultra-light Progeo - Standard! (colour: black)			
<input type="checkbox"/> 26" Progeo - Standard! (colour: black)			
<input type="radio"/> 24" ULTRA-LIGHT PROGEO KEY SPORT Weight reduction approx. 450gr. 04383 750.00			
<input type="radio"/> 24" Ultra-light "Spinergy LX" 01685 750.00			
<input type="radio"/> 24" Ultra-light "Spinergy LXL" 07846 750.00			
<input type="radio"/> 24" Ultra-light "Spinergy Flex rim" 02270 1,200.00			
<input type="radio"/> 25" Ultra-light "Spinergy LX" 02101 750.00			
<input type="radio"/> 25" Ultra-light "Spinergy LXL" 07847 750.00			
<input type="radio"/> 26" Ultra-light "Spinergy LX" 02102 750.00			
<input type="radio"/> 24" Off-road (aluminium handrim black) 01392 200.00			
<input type="radio"/> 22" with brake handles for companion (drum brake) (aluminium handrim) 03385 320.00			
Available only with camber 0° Not available with Frame Dynamic 2.0°			
<input type="radio"/> 24" with brake handles for companion (drum brake) (aluminium handrim) 03384 320.00			
Available only with camber 0° Not available with Frame Dynamic 2.0°			
<input type="radio"/> One arm drive - (24" rear wheels Aluminium handrim High pressure Tyre) - camber 0°			
<input type="radio"/> Right <input type="radio"/> Left			
02103 350.00			
Rear wheel tyre			
☆ High pressure tyre (22"-24"-25"-26")			
<input type="checkbox"/> High pressure profile tyre (24")			
<input type="radio"/> Marathon Plus (24"-25") with anti-puncture protection 01669 55.00			
<input type="radio"/> Anti-puncture - Colour Black (24") 11083 100.00			
<input type="radio"/> Anti-puncture - Colour Grey (24") 11083 100.00			
<input type="radio"/> Anti-puncture - Colour Grey (22") 04181 100.00			
Handrim Wheel distance ☆ 3 cm <input type="checkbox"/> 4 cm			
☆ Aluminium (22"-24"-25"-26")			
<input type="radio"/> Aluminium black SOFT-TOUCH (24"-25") (24" handrim, on 25" wheel is installed with spacers) 09170 100.00			
<input type="radio"/> Chromed Steel (24"-25") (24" handrim, on 25" wheel is installed with spacers) 01684 150.00			
<input type="radio"/> Titanium (24"-25") (24" handrim, on 25" wheel is installed with spacers) 00016 250.00			
<input type="radio"/> Ultra Grepp (24"-25") (24" handrim, on 25" wheel is installed with spacers) 00017 280.00			
<input type="radio"/> Max Grepp (24"-25") (24" handrim, on 25" wheel is installed with spacers) 00834 310.00			
<input type="radio"/> Ergo Para (24") 00632 310.00			
<input type="radio"/> TOP FRICTION (24"-25") (24" handrim, on 25" wheel is installed with spacers) 11023 260.00			
Oval countour with a rubber insert			
<input type="radio"/> NOVA H (24"-25") (24" handrim, on 25" wheel is installed with spacers) 11025 240.00			
Ergonomic black profile			
<input type="radio"/> NOVA D (24"-25") (24" handrim, on 25" wheel is installed with spacers) 11026 260.00			
Ergonomic profile with rubber coating (ideal for quadripelgics)			
<input type="radio"/> SURGE LT (25") Oval countour with a rubber insert 06427 290.00			
<input type="radio"/> Quad (24") 00693 180.00			
<input type="radio"/> Silicon cover for standard aluminium handrim Available for measures (22" - 24" - 26") 04050 150.00			

Date	Order	User name	Address
Wheel locks			
<input checked="" type="checkbox"/> Bent lever push to lock			
<input type="checkbox"/> Straight lever push to lock <input type="checkbox"/> Straight lever pull to lock			
<input type="radio"/> Sport brake		 06428 100.00	
<input type="radio"/> Brake with extension lever push to lock <input type="radio"/> Brake with extension lever pull to lock		 01949 60.00 03372 60.00	
Footplate - See reference tables N°3			
<input checked="" type="checkbox"/> Plastic footrest, rake adjustable (Minimum footplate distance 33cm.)		<input checked="" type="checkbox"/> 2/3 Internal <input type="checkbox"/> 2/3 External	
<input type="checkbox"/> Automatic Closure footplate, rake and depth adjustable (Minimum footplate distance 30cm.)		<input type="checkbox"/> Internal <input checked="" type="checkbox"/> 2/3 Internal <input type="checkbox"/> External	
<input type="radio"/> Minimum footplate distance 25cm. Available only with Multi-function and rotative system - 03945		160,00	
<input type="checkbox"/> One piece footplate - Flip-up! rake and depth adjustable (Minimum footplate distance 30cm.)		<input type="checkbox"/> Internal <input checked="" type="checkbox"/> 2/3 Internal <input type="checkbox"/> External	
<input type="radio"/> Minimum footplate distance 25cm. Available only with Multi-function and rotative system - 03945		160,00	
<input type="checkbox"/> One piece aluminium footplate - Flip-up! rake and depth adjustable (Minimum footplate distance 30cm.)		<input type="checkbox"/> Internal <input checked="" type="checkbox"/> 2/3 Internal <input type="checkbox"/> 2/3 External <input type="checkbox"/> External	
<input type="radio"/> One piece Carbon fibre footplate rake adjustable, swing away, flip-up. (Minimum footplate distance 30cm.)		<input checked="" type="checkbox"/> Internal <input type="checkbox"/> External	
		 03291 240.00	
<input type="radio"/> Footplate COMPACT, automatic Closure, rake and depth adjustable Minimum footplate distance 35cm.		<input checked="" type="checkbox"/> Internal <input type="checkbox"/> External	
		 09957 200.00	
Mudguard			
Mudguard - FIXED			
<input checked="" type="checkbox"/> ABS mudguard			
<input type="checkbox"/> ABS Straight sideguard			
<input type="radio"/> Carbon fibre mudguard		03946 260.00	
<input type="radio"/> Carbon fibre Straight sideguard		08918 250.00	
Mudguard - REMOVABLE			
<input type="radio"/> Removable ABS mudguard		08921 100.00	
<input type="radio"/> Removable ABS fibre straight sideguard		08921 100.00	
<input type="radio"/> Removable carbon fibre mudguard		08919 350.00	
<input type="radio"/> Removable Carbon fibre straight sideguard		08920 350.00	
Armrests			
<input type="radio"/> Tubular armrests		(Swing away, removable and height adjustable armrest)	
		<input type="radio"/> Standard Support (Not with frame Dynamic)	
		<input type="radio"/> Steel support with safety locking system	
		 04828 160.00 00694 220.00	
Removable armrest with ABS mudguard			
<input type="radio"/> Desk armrests PROGEO		(Removable and height adjustable) Not available with Frame Dynamic 2.0 + camber 4°	
		 09956 200.00	
<input type="radio"/> Removable armrest with ABS straight sideguard		08881 180.00	
<input type="radio"/> Removable armrest with carbon-fiber straight sideguard		08882 360.00	



















Date	Order	User name	Address
Accessories			
<input type="checkbox"/>	Pad for front frame protectors		07058 40.00
<input type="checkbox"/>	Backrest-seat connection cloth		10241 15.00
<input type="checkbox"/>	Removable storage bag (with quick coupling)		09811 110.00
Optional 1			
<input type="checkbox"/>	Transit wheels		00836 130.00
<input type="checkbox"/>	Anti-tipper with rapid hookup	(inside rotation to reduce the encumbrance) <input type="checkbox"/> Right <input type="checkbox"/> Left	 00023 110.00 00024 110.00
<input type="checkbox"/>	Tipping aid	<input type="checkbox"/> Right <input type="checkbox"/> Left	 00025 70.00 01046 70.00
<input type="checkbox"/>	Crutches support	<input type="checkbox"/> Right <input type="checkbox"/> Left	 00838 70.00 00837 70.00
Optional 2			
<input type="checkbox"/>	Tetraclip	(Quick release axle for quadriplegic)	03947 150.00
<input type="checkbox"/>	Rear wheels plate extension	(Not with frame Dynamic 2.0)	01950 160.00
<input type="checkbox"/>	Handybike adaptor	(Not with frame Dynamic 2.0)	 00506 70.00
<input type="checkbox"/>	Push handles for companion	(Removable and height adjustable)	 01048 170.00
<input type="checkbox"/>	Harness		04103 120.00
<input type="checkbox"/>	Safety pelvic belt		03972 60.00
<input type="checkbox"/>	Tray table (removable)		00508 240.00
<input type="checkbox"/>	Lumbar support	(to insert in the backrest upholstery)	00013 40.00
<input type="checkbox"/>	Super Head rest	(Folding with the wheelchair)	 04049 360.00
<input type="checkbox"/>	Swing away lateral support	<input type="checkbox"/> Right <input type="checkbox"/> Left	 02097 220.00 02098 220.00
	Not available with Posture backrest PHYSIO		
<input type="checkbox"/>	Spoke guards Black	(22"-24")	01043 140.00
<input type="checkbox"/>	Spoke guards Transparent	(22"-24")	00835 140.00
<input type="checkbox"/>	Spoke guards Progeo design	(22"-24")	00019 160.00
<input type="checkbox"/>	Spoke guards Dragon	(22"-24")	02106 160.00
Additional Kit			
<input type="checkbox"/>	24" Off-road rear wheels	Off-Road tyre - aluminium handrim (black colour)	03378 450.00
<input type="checkbox"/>	24" FAT rear wheels	FAT tyre 3" - aluminium handrim (black colour)	09357 750.00

Date	Order	User name	Address
------------	-------------	-----------------	---------------











PHYSIO - Posture backrest - Std. Backrest upholstery not provided

Removable with quick release
 Suitable for tubes with diameter 18+26mm
 Depth adjustment (4cm)
 Angle adjustment (±18°)

- AIR** Carbon shell
 not available for seat width 48

BACKREST HEIGHT	28	34	40																			
Shell's shape	Lateral retaining wing A=high - R=regular																					
 7.5 cm	<table border="1" style="width:100%; border-collapse: collapse;"> <tr> <th style="width:50%;">A</th> <th style="width:50%;">R</th> </tr> <tr> <td style="text-align: center;"></td> <td style="text-align: center;"></td> </tr> <tr> <td style="text-align: center;"><input type="checkbox"/></td> <td style="text-align: center;"><input type="checkbox"/></td> </tr> </table>	A	R			<input type="checkbox"/>	<input type="checkbox"/>	<table border="1" style="width:100%; border-collapse: collapse;"> <tr> <th style="width:50%;">A</th> <th style="width:50%;">R</th> </tr> <tr> <td style="text-align: center;"></td> <td style="text-align: center;"></td> </tr> <tr> <td style="text-align: center;"><input type="checkbox"/></td> <td style="text-align: center;"><input type="checkbox"/></td> </tr> </table>	A	R			<input type="checkbox"/>	<input type="checkbox"/>	<table border="1" style="width:100%; border-collapse: collapse;"> <tr> <th style="width:50%;">A</th> <th style="width:50%;">R</th> </tr> <tr> <td style="text-align: center;"></td> <td style="text-align: center;"></td> </tr> <tr> <td style="text-align: center;"><input type="checkbox"/></td> <td style="text-align: center;"><input type="checkbox"/></td> </tr> </table>	A	R			<input type="checkbox"/>	<input type="checkbox"/>	840.00
A	R																					
																						
<input type="checkbox"/>	<input type="checkbox"/>																					
A	R																					
																						
<input type="checkbox"/>	<input type="checkbox"/>																					
A	R																					
																						
<input type="checkbox"/>	<input type="checkbox"/>																					

- POSTURE** Aluminum shell

BACKREST HEIGHT	34	40	52										
Shell's shape	Lateral retaining wing B=regular												
 7.5 cm	<table border="1" style="width:100%; border-collapse: collapse;"> <tr> <th style="width:100%;">R</th> </tr> <tr> <td style="text-align: center;"></td> </tr> <tr> <td style="text-align: center;"><input type="checkbox"/></td> </tr> </table>	R		<input type="checkbox"/>	<table border="1" style="width:100%; border-collapse: collapse;"> <tr> <th style="width:100%;">R</th> </tr> <tr> <td style="text-align: center;"></td> </tr> <tr> <td style="text-align: center;"><input type="checkbox"/></td> </tr> </table>	R		<input type="checkbox"/>	<table border="1" style="width:100%; border-collapse: collapse;"> <tr> <th style="width:100%;">R</th> </tr> <tr> <td style="text-align: center;"></td> </tr> <tr> <td style="text-align: center;"><input type="checkbox"/></td> </tr> </table>	R		<input type="checkbox"/>	810.00
R													
													
<input type="checkbox"/>													
R													
													
<input type="checkbox"/>													
R													
													
<input type="checkbox"/>													

Configuration DEEP with side support PAD (height adjustable)

- Alluminum lateral with padded, breathable upholstery.



	Small (h 13cm) 		Large (h 20cm) 
	<input type="checkbox"/> Right 10272	25.00	<input type="checkbox"/> Right 10273
	<input type="checkbox"/> Left 10272	25.00	<input type="checkbox"/> Left 10273
			30.00

SWING AWAY - Lateral support

Fixing and adjustment hardware complete with protection sleeve
 Alluminum lateral with padded, breathable upholstery.

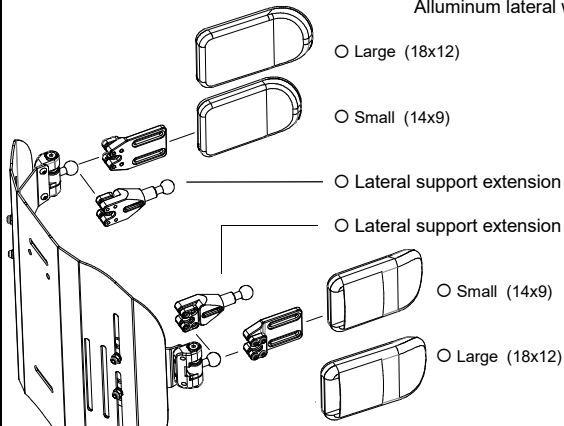

<input type="radio"/> Large (18x12)		05647 150.00
<input type="radio"/> Small (14x9)		05643 150.00
<input type="radio"/> Lateral support extension	Quantity (number pcs).....	
<input type="radio"/> Lateral support extension	10271 55.00	
<input type="radio"/> Small (14x9)		05642 150.00
<input type="radio"/> Large (18x12)		05646 150.00

- Headrest adjustable - Double ball mounting system
 Available only with backrest Physio
 Not available for backrest Physio AIR carbon shell

<input type="checkbox"/> Large (34x14)		05648 200.00
<input type="checkbox"/> Small (28x14)		



Date	Order	User name	Address
------------	-------------	-----------------	---------------

Note

Wheelchair : Progeo EXELLE - Rev. 2022.0	Prices in EURO - VAT excluded to be added to the price list	<div style="border: 1px solid black; padding: 2px;"> <p style="text-align: center; margin: 0;">Send this page only if any optional have been chosen</p> <p>☆ standard (supplied if no requests are indicated)</p> <p><input type="checkbox"/> on request (without extra charge)</p> <p><input type="radio"/> optional (cost to be added at the basic price)</p> </div>
--	--	---

REFERENCE TABLES

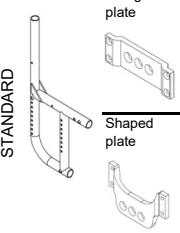
1	Front height	
With closed frame (95°) max 5" caster		
Casters	Front height	
	min.	max
3"	41	52
4"	42	53
5"	44	54
6"	48	55
7"	49	56
The size of the fork will be defined only by Progeo in accordance with wheelchair final configuration.		

2	Rear height			
Rear frame	Rear wheels			
	22"	24"	25"	26"
STANDARD 	Straight plate min. 37 max 45	min. 39 max 47	min. 40 max 48	min 41 max 49
	Shaped plate min. 36 max 49	min. 38 max 51	min. 39 max 52	min. 40 max 53
DYNAMIC 2.0 	min. 36 max 49	min. 38 max 51	min. 39 max 52	min. 40 max 53

3	Footplate option	Footplate distance	
		Frame Angle 110°	Frame Angle 100°
	Plastic footrest	min. 33	min. 31
	Automatic Closure footplate	min. 30	min. 28
	Automatic Closure footplate with multifunction rotative system	min. 25	min. 23
	One piece footplate - Flip-up!	min. 30	min. 28
	One piece footplate - Flip-up! , with multifunction rotative system	min. 25	min. 23
	One piece aluminium footplate - Flip-up!	min. 30	min. 28
	One piece Carbon fibre footplate	min. 30	min. 28
Calculated with the best configuration and with the footplates positioned on inside.			
IMPORTANT NOTICE! From the footplate to the floor minimum 4cm.!! (Minimum Front height = DP + 4cm.)			

4	Rear wheels	
	Model	Features
	22" Ultra-light Progeo - Standard!	(not available in anthracite color)
	24" Ultra-light Progeo - Standard!	(available for all colors)
	24" ULTRA-LIGHT PROGEO KEY SPORT	(silver hub, black rim and 16 spokes)
	24" Ultra-light "Spinergy LX"	(silver hub, black rim and spokes)
	24" Ultra-light "Spinergy LXL"	(black hub and rim, 18 white spokes) - (black hub, rim and 18 spokes)
	24" Ultra-light "Spinergy Flex rim"	(silver hub, black rim and spokes) - (integrated aluminium/rubber handrim - encumbrance reduction up to 3cm. - all tyre)
	24" Off-road	(colour: black) - (aluminium handrim - tyre Off-road)
	25" Ultra-light "Spinergy LX"	(silver hub, black rim and spokes)
	25" Ultra-light "Spinergy LXL"	(black hub and rim, 18 white spokes)
	26" Progeo - Standard!	(colour: black)
	26" Ultra-light "Spinergy LX"	(silver hub, black rim and 18 spokes)