

Date	Order	User name	Address
------------	-------------	-----------------	---------------

Seat

☆ Seat cloth with pocket (under seat)

Seat with tension straps 08883 **200.00**

Carbon rigid seat 08336 **400.00**

Pocket (under seat) [25x11x4,5] 08281 **60.00**

Backrest adjustment and fixing system

☆ Backrest with double locking (upright and folded) with rake adjustable from -4° to +16°

Backrest with upright locking system ONLY (no locking when folded) with rake adjustable from -4° to +16°

Fixed back(non-folding back) with rake adjustable from -4° to +16°

Backrest

☆ Adjustable velcro straps and padded transpiring upholstery



☆ Aluminium backrest 

Titanium backrest 06811 **160.00** 

Carbon fibre backrest 04389 **600.00** 

AIR Integrated posture backrest (NOT REMOVABLE) **840.00**

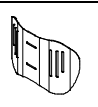
Carbon shell - Lateral retaining 7,5cm
Depth adjustment ±1cm. - Angle adjustment ±10°
not available for seat width 48

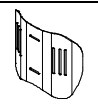
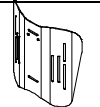
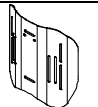
H 28 Backrest Height (TS) min 34 (.....)	H 34 Backrest Height (TS) min 38 (.....)	H 40 Backrest Height (TS) min 44 (.....)
Lateral retaining wing A=high - R=regular		
A	R	A
		
<input type="checkbox"/>	<input type="checkbox"/>	<input type="checkbox"/>
A	R	A
		
<input type="checkbox"/>	<input type="checkbox"/>	<input type="checkbox"/>

Installation on:

☆ Backrest tubes

Aluminium backrest 

Titanium backrest 06811 **160.00** 

Carbon fibre backrest 04389 **600.00** 

Handle tube

☆ Tubes with short handle

SPORT tubes Without push handles

Carbon fibre tubes with short handle (Lightest configuration) 04390 **120.00**

Not available with: Posture backrest PHYSIO - Posture backrest A I R

Folding handles  02958 **200.00**

Colour set: Rear wheels and forks - To be matched only with: Rear wheels Ultra-light Progeo - Standard! (22 - 24)

☆ Black	22" 24" 25" 26"		
<input type="radio"/> Bright silver	22" 24"	00833	110.00
<input type="radio"/> Bright orange	22" 24"	00833	110.00
<input type="radio"/> Bright anthracite	24"	00833	110.00
<input type="radio"/> Bright fuchsia	22" 24"	00833	110.00
<input type="radio"/> Bright blue	22" 24"	00833	110.00
<input type="radio"/> Bright red	22" 24"	00833	110.00
<input type="radio"/> Bright lime	22" 24"	00833	110.00
<input type="radio"/> Pearl white	22" 24"	00833	110.00

Casters

☆ 4" Soft

3" Sport (Lightest configuration)

5" Soft Not available with frame angle 90° to the floor

3" Active Soft (wide) - Aluminium alloy rim 06824 **110.00**

4" Active Sport (narrow) - Aluminium alloy rim 01398 **110.00**

4" Active Soft (wide) - Aluminium alloy rim 03943 **110.00**

5" Active Soft (wide) - Aluminium alloy rim Not available with frame angle 90° to the floor 07518 **110.00**





5" Pneumatic Not available with frame angle 90° to the floor 10844 **50.00**

Date	Order	User name	Address
------------	-------------	-----------------	---------------

Rear wheels			
☆ 24" Ultra-light Progeo - Standard!			
<input type="checkbox"/> 22" Ultra-light Progeo - Standard!			
<input type="checkbox"/> 25" Ultra-light Progeo - Standard!		(colour: black)	
<input type="checkbox"/> 26" Progeo - Standard!		(colour: black)	
<input type="radio"/> 24" ULTRA-LIGHT PROGEO KEY SPORT		(Lightest configuration)	04383 750.00
<input type="radio"/> 24" Ultra-light "Spinergy LX"			01685 750.00
<input type="radio"/> 24" Ultra-light "Spinergy LXL"	<input type="checkbox"/> Black hub and white spokes	<input type="checkbox"/> Hub and spokes black	07846 750.00
<input type="radio"/> 24" Ultra-light "Spinergy Flex rim"	Integrated aluminium/rubber handrim		02270 1,200.00
<input type="radio"/> 25" Ultra-light "Spinergy LX"			02101 750.00
<input type="radio"/> 25" Ultra-light "Spinergy LXL"	<input type="checkbox"/> Black hub and white spokes		07847 750.00
<input type="radio"/> 26" Ultra-light "Spinergy LX"			02102 750.00
<input type="radio"/> 24" Off-road (aluminium handrim black)			01392 200.00

Rear wheel tyre			
☆ High pressure tyre	(22"-24"-25"-26")	(Lightest configuration)	
<input type="checkbox"/> High pressure profile tyre	(24")		
<input type="radio"/> Marathon Plus	(24"-25")	with anti-puncture protection	01669 55.00
<input type="radio"/> Anti-puncture - Colour Grey	(22")		04181 100.00
<input type="radio"/> Anti-puncture - Colour Black	(24")		11083 100.00
<input type="radio"/> Anti-puncture - Colour Grey	(24")		11083 100.00

Handrim		Wheel distance ☆ 3 cm	<input type="checkbox"/> 4 cm	
☆ Aluminium	(22"-24"-25"-26")	(Lightest configuration)		
<input type="radio"/> Aluminium black SOFT-TOUCH	(24"-25")	(24" handrim, on 25" wheel is installed with spacers)	09170	100.00
<input type="radio"/> Chromed Steel	(24"-25")	(24" handrim, on 25" wheel is installed with spacers)	01684	150.00
<input type="radio"/> Titanium	(24"-25")	(24" handrim, on 25" wheel is installed with spacers)	00016	250.00
<input type="radio"/> Ultra Grepp	(24"-25")	(24" handrim, on 25" wheel is installed with spacers)	00017	280.00
<input type="radio"/> Max Grepp	(24"-25")	(24" handrim, on 25" wheel is installed with spacers)	00834	310.00
<input type="radio"/> Ergo Para	(24")		00632	310.00
<input type="radio"/> TOP FRICTION	(24"-25")	(24" handrim, on 25" wheel is installed with spacers)	11023	260.00
Oval countour with a rubber insert				
<input type="radio"/> NOVA H	(24"-25")	(24" handrim, on 25" wheel is installed with spacers)	11025	240.00
Ergonomic black profile				
<input type="radio"/> NOVA D	(24"-25")	(24" handrim, on 25" wheel is installed with spacers)	11026	260.00
Ergonomic profile with rubber coating (ideal for quadriplegics)				
<input type="radio"/> SURGE LT	(25")	Oval countour with a rubber insert	06427	290.00
<input type="radio"/> Quad	(24")		00693	180.00
<input type="radio"/> Silicon cover for standard aluminium handrim		Available for measures (22" - 24" - 26")	04050	150.00





Wheel locks			
☆ Bent lever push to lock			
<input type="checkbox"/> Straight lever push to lock			
<input type="checkbox"/> Straight lever pull to lock			
<input type="radio"/> Sport brake		(Lightest configuration)	06428 100.00
<input type="radio"/> Brake with extension lever push to lock			01949 60.00
<input type="radio"/> Brake with extension lever pull to lock			03372 60.00



Mudguard			
☆ Carbon fibre mudguard			
<input type="checkbox"/> Carbon fibre Straight sideguard	☆ Aligned wheel	<input type="checkbox"/> Under wheel cm	<input type="checkbox"/> Above wheel cm
<input type="radio"/> Removable carbon fibre mudguard			04109 200.00
<input type="radio"/> Removable Carbon fibre straight sideguard	☆ Aligned wheel	<input type="checkbox"/> Under wheel cm	<input type="checkbox"/> Above wheel cm
<input type="radio"/> Welded straight mudguard	Available only with made-to-measure welded frame and fixed and welded backrest		08933 400.00
	☆ Aligned wheel	<input type="checkbox"/> Under wheel cm	<input type="checkbox"/> Above wheel cm

Date	Order	User name	Address
------------	-------------	-----------------	---------------

Armrests			
<input type="radio"/> Tubular armrests	(Swing away, removable and height adjustable armrest)		00694 220.00

Accessories			
<input type="radio"/> Pad for front frame protectors			07058 40.00
<input type="radio"/> Backrest-seat connection cloth			10241 15.00
<input type="radio"/> Removable storage bag (with quick coupling)			09811 110.00

Optional 1			
<input type="checkbox"/> Set-up for post-sale optional assembly			
<input type="radio"/> Transit wheels			03290 130.00
<input type="radio"/> Crutches support	<input type="radio"/> Right <input type="radio"/> Left		00838 70.00 00837 70.00
<input type="radio"/> Anti-tipper with rapid hookup	(inside rotation to reduce the encumbrance) <input type="radio"/> Right <input type="radio"/> Left		06821 110.00 06822 110.00
<input type="radio"/> Tipping aid	<input type="radio"/> Right <input type="radio"/> Left		00025 70.00 01046 70.00

Optional 2			
<input type="radio"/> Push handles for companion	(Removable and height adjustable)		03645 170.00
<input type="radio"/> Tetraclip	(Quick release axle for quadriplegic)		03947 150.00
<input type="radio"/> Safety pelvic belt			03972 60.00
<input type="radio"/> Harness			04103 120.00
<input type="radio"/> Lumbar support	(to insert in the backrest upholstery)		00013 40.00
<input type="radio"/> Swing away lateral support	<input type="radio"/> Right <input type="radio"/> Left		02097 220.00 02098 220.00
Not available with: Posture backrest PHYSIO - Posture backrest A I R			
<input type="radio"/> Spoke guards Black	(22"-24")		01043 140.00
<input type="radio"/> Spoke guards Transparent	(22"-24")		00835 140.00
<input type="radio"/> Spoke guards Progeo design	(22"-24")		00019 160.00
<input type="radio"/> Spoke guards Dragon	(22"-24")		02106 160.00







Additional Kit			
<input type="radio"/> 24" Off-road rear wheels	Off-Road tyre - aluminium handrim (black colour)		03378 450.00
<input type="radio"/> 24" FAT rear wheels	FAT tyre 3" - aluminium handrim (black colour)		09357 750.00

Date Order User name Address

PHYSIO - Posture backrest - Std. Backrest upholstery not provided



Removable with quick release
 Suitable for tubes with diameter 18÷26mm
 Depth adjustment (4cm)
 Angle adjustment (±18°)

- AIR** Carbon shell
 not available for seat width 48

BACKREST HEIGHT	28	34	40			
Shell's shape 	Lateral retaining wing A=high - R=regular					
	A	R	A	R	A	R
						
	<input type="checkbox"/>	<input type="checkbox"/>	<input type="checkbox"/>	<input type="checkbox"/>	<input type="checkbox"/>	<input type="checkbox"/>

840.00

- POSTURE** Aluminum shell

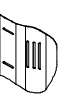
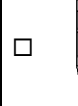
BACKREST HEIGHT	34	40	52			
Shell's shape 	Lateral retaining wing B=regular					
	R	R	R			
						
	<input type="checkbox"/>	<input type="checkbox"/>	<input type="checkbox"/>			

810.00

Configuration DEEP with side support PAD (height adjustable)

- Aluminum lateral with padded, breathable upholstery.



Small (h 13cm)



Right 10272

25.00



Left 10272

25.00

Large (h 20cm)



Right 10273

30.00



Left 10273

30.00

SWING AWAY - Lateral support

Fixing and adjustment hardware complete with protection sleeve
 Aluminum lateral with padded, breathable upholstery.

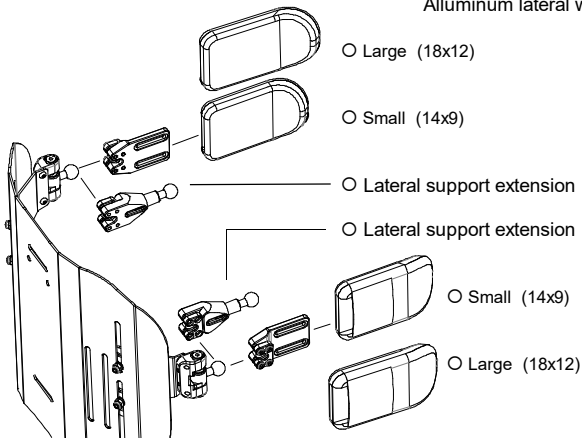

- Large (18x12)

05647 150.00

- Small (14x9)

05643 150.00

- Lateral support extension

Quantity (number pcs).....
 10271 55.00

- Lateral support extension

Quantity (number pcs).....

- Small (14x9)

05642 150.00

- Large (18x12)

05646 150.00

- Headrest adjustable - Double ball mounting system



Available only with backrest Physio
 Not available for backrest Physio AIR carbon shell

Large (34x14) 05648 200.00
 Small (28x14)

Date Order User name Address

1	A Footplate width			
	DP	35÷39	40÷45	46÷50
LS				
33	21	20	19	
36	24	23	22	
39	26	25	24	
42	29	28	27	
45	32	31	30	
48	35	34	33	

2	Setting	C :
	Extremely prudential	7.5
	Prudential	9
	Standard	10.5
	Active	12
	Extreme	13.5

3	Lt
Camber	Maximum width
0°	LS + 18
2°	LS + 21
4°	LS + 24
8°	LS + 30
12°	LS + 36

Maximum width calculated including 3 cm. distance between tyre and handrim

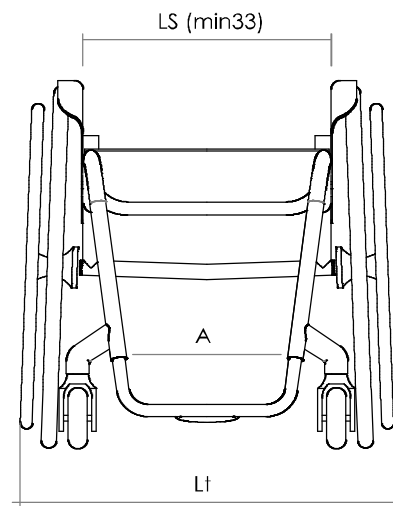
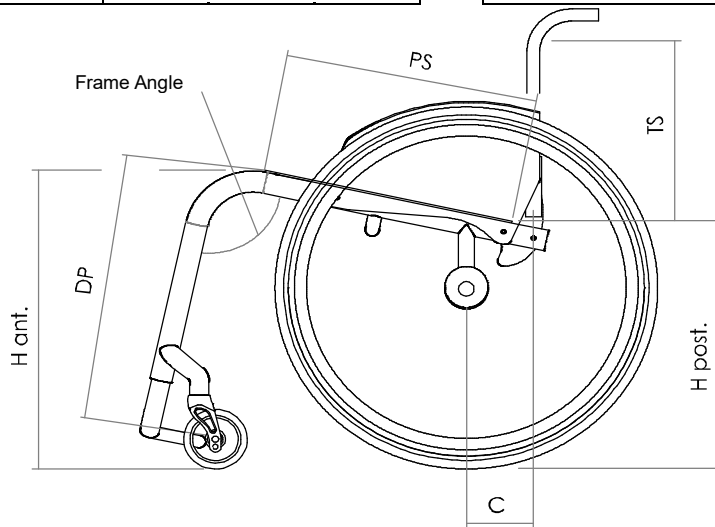

Wheelchair : Progeo JOKER ENERGY - Rev. 2022.0

Prices in EURO - VAT excluded
to be added to the price list

Send this page only if any optional have been chosen

☆	standard	(supplied if no requests are indicated)
□	on request	(without extra charge)
○	optional	(cost to be added at the basic price)