

permobil Order Form - Progeo JOKER

Date

User name

Responsible

Company stamp

Rigid frame wheelchair
CRASH TEST APPROVED

Wheelchair measures							
Seat width (LS)	<input type="checkbox"/> 33	<input type="checkbox"/> 36	<input type="checkbox"/> 39	<input type="checkbox"/> 42	<input type="checkbox"/> 45	<input type="checkbox"/> 48	
Seat depth (PS)	<input type="checkbox"/> 35	<input type="checkbox"/> 37,5	<input type="checkbox"/> 40	<input type="checkbox"/> 42,5	<input type="checkbox"/> 45	<input type="checkbox"/> 47,5	<input type="checkbox"/> 50
The real seat depth, from the front part of the seat cloth to the backrest tube will be 1,5 cm more than the declared one.							
Footplate distance (DP)	<u>(Real distance between seat and footplate)</u>						
IMPORTANT NOTICE! From the footplate to the floor minimum 4cm.!! (Minimum Front height = DP + 4cm.)							
Setting	☆ Standard		<input type="checkbox"/> Prudential	<input type="checkbox"/> Active	<input type="checkbox"/> Extreme		
Backrest Height (TS)	Std.Value 33,5(min 24.5-max 47)						
camber	☆ 0° <input type="checkbox"/> 2° <input type="checkbox"/> 4°						
Front height STD 49			Rear height STD 42		

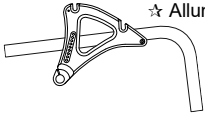
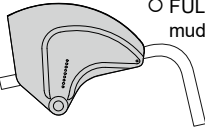
	☆ Alluminum rear adjustment plate		
	☆ Removable mudguard ABS		
	<input type="checkbox"/> Removable ABS fibre straight sideguard		
	<input type="checkbox"/> Removable carbon fibre mudguard	03946	260.00
	<input type="checkbox"/> Removable Carbon fibre straight sideguard	08918	250.00
	<input type="checkbox"/> FULL CARBON rear adjustment plate with integrated mudguard	07646	800.00
	☆ Version mudguard (Available only with rear wheels 24")		
	<input type="checkbox"/> Version straight sideguard		

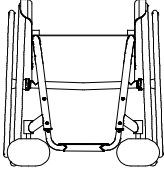
JOKER		☆ Aluminium footplate, rake adjustable Minimum footplate distance 35cm.		
		☆ Internal <input type="checkbox"/> 2/3 Internal		
		<input type="checkbox"/> External <input type="checkbox"/> 2/3 External		
		<input type="checkbox"/> Aluminium footplate EVOLUTION - rake and depth adjustable Minimum footplate distance 35cm.	07649	120.00
	☆ Internal <input type="checkbox"/> 2/3 Internal			
	<input type="checkbox"/> External <input type="checkbox"/> 2/3 External			
	<input type="checkbox"/> One piece Carbon fibre footplate JOKER Minimum footplate distance 35cm. not available for seat width 48	03348	240.00	
	<input type="checkbox"/> One piece Carbon fibre footplate, rake adjustable Minimum footplate distance 35cm.	03346	260.00	
	☆ Internal <input type="checkbox"/> External			

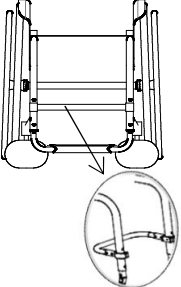
JOKER ZERO		<input type="checkbox"/> Plastic footrest, rake adjustable Minimum footplate distance 15cm.		
		☆ 2/3 Internal <input type="checkbox"/> 2/3 External		
		<input type="checkbox"/> One piece aluminium footplate - Flip-up!, rake and depth adjustable Minimum footplate distance 15cm.	06814	170.00
	☆ Internal <input type="checkbox"/> 2/3 Internal			
	<input type="checkbox"/> External <input type="checkbox"/> 2/3 External			
	<input type="checkbox"/> One piece Carbon fibre footplate rake adjustable, swing away, flip-up. Minimum footplate distance 15cm.	06856	170.00	
	☆ Internal <input type="checkbox"/> External			
	<input type="checkbox"/> One piece Carbon fibre footplate rake adjustable, swing away, flip-up. Minimum footplate distance 15cm.	06857	400.00	
	☆ Internal <input type="checkbox"/> External			

Date	Order	User name	Address
------------	-------------	-----------------	---------------

Front frame

☆ Aluminium standard frame

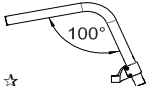

☆

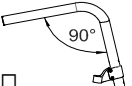

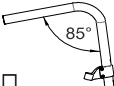

(max 4" caster)

Colour aluminium frame

☆ Bright silver

Polished black

Opaque black

Bright blue

Bright anthracite

Bright orange

Bright fuchsia

Bright red

Bright lime

Bright blue china

Pearl white

Seat

☆ Seat cloth with pocket (under seat)

Seat with tension straps 08883 **200.00**

Carbon rigid seat 08336 **400.00**

Pocket (under seat) [25x11x4,5] 08281 **60.00**

Rear wheels axle

☆ Aluminum rear wheels axle

Carbon fiber rear wheels axle (Lightest configuration) 07647 **140.00**

Backrest adjustment and fixing system

☆ Backrest with double locking (upright and folded)
with rake adjustable from -4° to +16°

Backrest with upright locking system ONLY (no locking when folded)
with rake adjustable from -4° to +16°

Fixed back(non-folding back)
with rake adjustable from -4° to +16°



Backrest

☆ Adjustable velcro straps and padded transpiring upholstery

☆ Aluminium backrest

Titanium backrest 06811 **160.00**

Carbon fibre backrest 04389 **600.00**











06811 **160.00**

04389 **600.00**

AIR **Integrated posture backrest (NOT REMOVABLE)** **840.00**

Carbon shell - Lateral retaining 7,5cm
Depth adjustment ±1cm. - Angle adjustment ±10°
not available for seat width 48

H 28		H 34		H 40	
Backrest Height (TS) min 34 (.....)		Backrest Height (TS) min 38 (.....)		Backrest Height (TS) min 44 (.....)	
Lateral retaining wing A=high - R=regular					
A	R	A	R	A	R
					
<input type="checkbox"/>	<input type="checkbox"/>	<input type="checkbox"/>	<input type="checkbox"/>	<input type="checkbox"/>	<input type="checkbox"/>





Installation on:

☆ Backrest tubes







Aluminium backrest

Titanium backrest 06811 **160.00**

Carbon fibre backrest 04389 **600.00**

Date	Order	User name	Address
Handle tube			
☆ Tubes with standard handle			
<input type="checkbox"/> Tubes with short handle			
<input type="checkbox"/> SPORT tubes Without push handles			
<input type="radio"/> Carbon fibre tubes with short handle	(Lightest configuration)	04390	120.00
Not available with: Posture backrest PHYSIO - Posture backrest A I R			
<input type="radio"/> Folding handles		 02958	200.00
Casters			
☆ 4" Soft			
<input type="checkbox"/> 3" Sport (Lightest configuration)			
<input type="checkbox"/> 5" Soft			
<input type="checkbox"/> 6" Soft (Available only with 100° angle)			
<input type="checkbox"/> 6" Pneumatic (Available only with 100° angle)			
<input type="radio"/> 3" Active Soft (wide)	(Aluminium alloy rim)	06824	110.00
<input type="radio"/> 4" Active Sport (narrow)	(Aluminium alloy rim)	01398	110.00
<input type="radio"/> 4" Active Soft (wide)	(Aluminium alloy rim)	03943	110.00
<input type="radio"/> 5" Active Soft (wide)	(Aluminium alloy rim)	07518	110.00
<input type="radio"/> 5" Pneumatic		10844	50.00
Colour set: Rear wheels and forks - To be matched only with: Rear wheels Ultra-light Progeo - Standard! (22 - 24)			
☆ Black	22" 24" 25" 26"		
<input type="radio"/> Bright silver	22" 24"	00833	110.00
<input type="radio"/> Bright anthracite	24"	00833	110.00
<input type="radio"/> Bright orange	22" 24"	00833	110.00
<input type="radio"/> Bright fuchsia	22" 24"	00833	110.00
<input type="radio"/> Bright blue	22" 24"	00833	110.00
<input type="radio"/> Bright red	22" 24"	00833	110.00
<input type="radio"/> Bright lime	22" 24"	00833	110.00
<input type="radio"/> Pearl white	22" 24"	00833	110.00
Rear wheels			
☆ 24" Ultra-light Progeo - Standard!			
<input type="checkbox"/> 22" Ultra-light Progeo - Standard!			
<input type="checkbox"/> 25" Ultra-light Progeo - Standard! (colour: black)			
<input type="checkbox"/> 26" Progeo - Standard! (colour: black)			
<input type="radio"/> 24" ULTRA-LIGHT PROGEO KEY SPORT	Weight reduction approx. 450gr.	04383	750.00
<input type="radio"/> 24" Ultra-light "Spinergy LX"		01685	750.00
<input type="radio"/> 24" Ultra-light "Spinergy LXL"	<input type="checkbox"/> Black hub and white spokes <input type="checkbox"/> Hub and spokes black	07846	750.00
<input type="radio"/> 24" Ultra-light "Spinergy Flex rim"	Integrated aluminium/rubber handrim	02270	1,200.00
<input type="radio"/> 25" Ultra-light "Spinergy LX"		02101	750.00
<input type="radio"/> 25" Ultra-light "Spinergy LXL"	<input type="checkbox"/> Black hub and white spokes	07847	750.00
<input type="radio"/> 26" Ultra-light "Spinergy LX"		02102	750.00
<input type="radio"/> 24" Off-road (aluminium handrim black)		01392	200.00
Rear wheel tyre			
☆ High pressure tyre	(22"-24"-25"-26")	(Lightest configuration)	
<input type="checkbox"/> High pressure profile tyre (24")			
<input type="radio"/> Marathon Plus	(24"-25")	with anti-puncture protection	01669 55.00
<input type="radio"/> Anti-puncture - Colour Grey	(22")		04181 100.00
<input type="radio"/> Anti-puncture - Colour Black	(24")		11083 100.00
<input type="radio"/> Anti-puncture - Colour Grey	(24")		11083 100.00
Handrim			
Wheel distance ☆ 3 cm		<input type="checkbox"/> 4 cm	
☆ Aluminium	(22"-24"-25"-26")	(Lightest configuration)	
<input type="radio"/> Aluminium black SOFT-TOUCH	(24"-25")	(24" handrim, on 25" wheel is installed with spacers)	09170 100.00
<input type="radio"/> Chromed Steel	(24"-25")	(24" handrim, on 25" wheel is installed with spacers)	01684 150.00
<input type="radio"/> Titanium	(24"-25")	(24" handrim, on 25" wheel is installed with spacers)	00016 250.00
<input type="radio"/> Ultra Grepp	(24"-25")	(24" handrim, on 25" wheel is installed with spacers)	00017 280.00
<input type="radio"/> Max Grepp	(24"-25")	(24" handrim, on 25" wheel is installed with spacers)	00834 310.00
<input type="radio"/> Ergo Para	(24")		00632 310.00
<input type="radio"/> TOP FRICTION	(24"-25")	(24" handrim, on 25" wheel is installed with spacers)	11023 260.00
Oval countour with a rubber insert			
<input type="radio"/> NOVA H	(24"-25")	(24" handrim, on 25" wheel is installed with spacers)	11025 240.00
Ergonomic black profile			
<input type="radio"/> NOVA D	(24"-25")	(24" handrim, on 25" wheel is installed with spacers)	11026 260.00
Ergonomic profile with rubber coating (ideal for quadriplegics)			
<input type="radio"/> SURGE LT	(25")	Oval countour with a rubber insert	06427 290.00
<input type="radio"/> Quad (24")	(24")		00693 180.00
<input type="radio"/> Silicon cover for standard aluminium handrim		Available for measures (22" - 24" - 26")	04050 150.00

Date	Order	User name	Address
Wheel locks			
<input checked="" type="checkbox"/> Bent lever push to lock <input type="checkbox"/> Straight lever push to lock <input type="checkbox"/> Straight lever pull to lock <input type="checkbox"/> Sport brake <input type="checkbox"/> Brake with extension lever push to lock <input type="checkbox"/> Brake with extension lever pull to lock		(Lightest configuration)	 06428 100.00 01949 60.00 03372 60.00
Armrests			
<input type="checkbox"/> Tubular armrests		(Swing away, removable and height adjustable armrest)	 00694 220.00
Accessories			
<input type="checkbox"/> Pad for front frame protectors <input type="checkbox"/> Backrest-seat connection cloth <input type="checkbox"/> Removable storage bag (with quick coupling)			07058 40.00 10241 15.00 09811 110.00
SAFETY			
<input type="checkbox"/> 4 points tie-down system rings			08654 170.00
Optional 1			
<u>Only one optional devices for side can be chosen</u>			
<input type="checkbox"/> Transit wheels		Exclude the installation of Anti-tippers	 03290 130.00
<input type="checkbox"/> Anti-tipper BASE		Exclude the installation of Transit wheels <input type="radio"/> Right <input type="radio"/> Left	06819 90.00 06820 90.00
<input type="checkbox"/> Anti-tipper with rapid hookup (inside rotation to reduce the encumbrance)		Exclude the installation of Transit wheels <input type="radio"/> Right <input type="radio"/> Left	 06821 110.00 06822 110.00
Optional 2			
<input type="checkbox"/> Push handles for companion		(Removable and height adjustable)	 03645 170.00
<input type="checkbox"/> Tetraclip		(Quick release axle for quadriplegic)	03947 150.00
<input type="checkbox"/> Safety pelvic belt			03972 60.00
<input type="checkbox"/> Lumbar support		(to insert in the backrest upholstery)	00013 40.00
<input type="checkbox"/> Swing away lateral support		Not available with Posture backrest PHYSIO - Posture backrest A I R <input type="radio"/> Right <input type="radio"/> Left	 02097 220.00 02098 220.00
<input type="checkbox"/> Spoke guards Black <input type="checkbox"/> Spoke guards Transparent <input type="checkbox"/> Spoke guards Progeo design <input type="checkbox"/> Spoke guards Dragon		(22"-24") (22"-24") (22"-24") (22"-24")	01043 140.00 00835 140.00 00019 160.00 02106 160.00
Additional Kit			
<input type="checkbox"/> 24" Off-road rear wheels		Off-Road tyre - aluminium handrim (black colour)	03378 450.00
<input type="checkbox"/> 24" FAT rear wheels		FAT tyre 3" - aluminium handrim (black colour)	09357 750.00

Date Order User name Address

PHYSIO - Posture backrest - Std. Backrest upholstery not provided

Removable with quick release
 Suitable for tubes with diameter 18÷26mm
 Depth adjustment (4cm)
 Angle adjustment (±18°)

- AIR** Carbon shell
 not available for seat width 48

BACKREST HEIGHT	28	34	40			
Shell's shape 7,5 cm	Lateral retaining wing A=high - R=regular					
	A	R	A	R	A	R
	<input type="checkbox"/>	<input type="checkbox"/>	<input type="checkbox"/>	<input type="checkbox"/>	<input type="checkbox"/>	<input type="checkbox"/>

840.00

- POSTURE** Aluminum shell

BACKREST HEIGHT	34	40	52	
Shell's shape 7,5 cm	Lateral retaining wing B=regular			
	R	R	R	
	<input type="checkbox"/>	<input type="checkbox"/>	<input type="checkbox"/>	

810.00

Configuration DEEP with side support PAD (height adjustable)

- Aluminum lateral with padded, breathable upholstery.



Small (h 13cm)



Right
10272

25.00

Left
10272

25.00

Large (h 20cm)



Right
10273

30.00

Left
10273

30.00

SWING AWAY - Lateral support

Fixing and adjustment hardware complete with protection sleeve
 Aluminum lateral with padded, breathable upholstery.

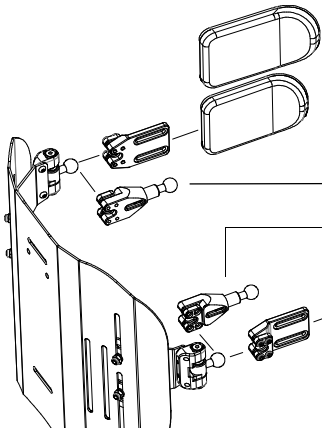

Large (18x12)

05647

150.00

Small (14x9)

05643

150.00

Lateral support extension

Quantity (number pcs) (.....)

10271

55.00

Lateral support extension

Quantity (number pcs) (.....)

Small (14x9)

05642

150.00

Large (18x12)

05646

150.00

- Headrest adjustable - Double ball mounting system

Available only with backrest Physio
 Not available for backrest Physio AIR carbon shell



Large (34x14)
 Small (28x14)

05648

200.00

Date	Order	User name	Address
------------	-------------	-----------------	---------------

--

--

--



--

Note

Wheelchair : Progeo JOKER - Rev. 2022.0	Prices in EURO - VAT excluded to be added to the price list	Send this page only if any optional have been chosen	
		<input checked="" type="checkbox"/> standard	(supplied if no requests are indicated)

<input type="checkbox"/> on request	(without extra charge)
<input type="checkbox"/> optional	(cost to be added at the basic price)

REFERENCE TABLES

1		Front height			
With closed frame (95°) max 5" caster					
With closed frame (90°) max 5" caster					
With closed frame (85°) max 4" caster					
FORK		Casters			
		3"	4"	5"	6"
SPORT		max 52	max 53	max 54	
SMALL		max 54	max 55	max 56	max 57
MEDIUM		max 56	max 57	max 58	max 59

The size of the fork will be defined only by Progeo in accordance with wheelchair final configuration.

2		Rear height			
Rear wheels					
		22"	24"	25"	26"
min 36		min 38	min 39	min 40	
max 44		max 46	max 47	max 48	

3	Footplate option	Footplate distance
	Aluminium footplate rake adjustable	min 35
	One piece Carbon fibre footplate	min 35
	One piece Carbon fibre footplate rake adjustable	min 35
	Plastic footrest, rake adjustable	min 35
	One piece aluminium footplate - Flip-up! rake and depth adjustable	min 35
	One piece Carbon fibre footplate rake adjustable, swing away, flip-up.	min 35
IMPORTANT NOTICE! From the footplate to the floor minimum 4cm.!! (Minimum Front height = DP + 4cm.)		
Calculated with the best configuration and with the footplates positioned on inside.		
NOTE! Lower footplate distances are possible only after our valuation		

4	Rear wheels	
	Model	Features
	22" Ultra-light Progeo - Standard!	(not available in anthracite color)
	24" Ultra-light Progeo - Standard!	(available for all colors)
	24" ULTRA-LIGHT PROGEO KEY SPORT	(silver hub, black rim and 16 spokes)
	24" Ultra-light "Spinergy LX"	(silver hub, black rim and spokes)
	24" Ultra-light "Spinergy LXL"	(black hub and rim, 18 white spokes) - (black hub, rim and 18 spokes)
	24" Ultra-light "Spinergy Flex rim"	(silver hub, black rim and spokes) - (integrated aluminium/rubber handrim - encumbrance reduction up to 3cm. - all tyre)
	24" Off-road	(colour: black) - (aluminium handrim - tyre Off-road)
	25" Ultra-light "Spinergy LX"	(silver hub, black rim and spokes)
	25" Ultra-light "Spinergy LXL"	(black hub and rim, 18 white spokes)
	26" Progeo - Standard!	(colour: black)
	26" Ultra-light "Spinergy LX"	(silver hub, black rim and 18 spokes)

Wheelchair : Progeo JOKER - Rev. 2022.0