

Date Progeo (English)
 User Company stamp
 End user weight (kg)
 Language user manual Responsible

Folding frame wheelchair

Wheelchair measures - The tolerance on all the dimensions indicated and/or required is ± 10 mm

Seat width (LS) 36 39 42 45

Seat depth (PS) 35 37,5 40 42,5 45 47,5
 The real seat depth, from the front part of the seat cloth to the backrest tube will be 2 cm more than the declared one.

Footplate distance (DP) (cm) ±0.5cm - adjustment steps 1.5cm
(Real distance between seat and footplate) - IMPORTANT NOTICE! From the footplate to the floor minimum 4cm !! (Minimum Front height = DP + 4cm)
See reference tables N°3

Setting Standard Prudential Active

Backrest Height (TS) Std.Value 33,5(min 24.5-max 47) adjustment steps 1.5cm

Backrest rake adjustable from -4° to +12°

Camber 0° 2°

Front height (STD 49) - Rear height (STD 43)

Front frame

Aluminium standard frame Angle 100°

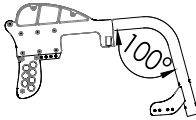

Aluminium frame Angle 90° - (max 5" caster)

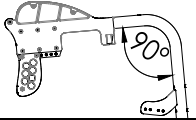

Frame colour

- Bright silver
- Polished black
- Bright blue
- Bright fuchsia
- Bright red
- Bright lime
- Bright blue china
- Pearl white

Backrest

Adjustable velcro straps and padded transpiring upholstery

Handle tube

Tubes with standard handle



Folding handles
 Not available with: Push handles for companion

02958 **232,00**

Colour set: Rear wheels and forks - To be matched only with: Rear wheels Ultra-light Progeo - Standard! (22 - 24)

<input checked="" type="checkbox"/> Polished black	22" 24" 25" 26"		
<input type="checkbox"/> Bright silver	22" 24"	00833	137,00
<input type="checkbox"/> Bright fuchsia	22" 24"	00833	137,00
<input type="checkbox"/> Bright blue	22" 24"	00833	137,00
<input type="checkbox"/> Bright red	22" 24"	00833	137,00
<input type="checkbox"/> Bright lime	22" 24"	00833	137,00
<input type="checkbox"/> Pearl white	22" 24"	00833	137,00

Casters

4" Soft

- 3" Sport
- 5" Soft
- 6" Soft
- 6" Pneumatic

(Available only with 100° angle)
 (Available only with 100° angle)

<input type="checkbox"/> 3" Active Soft (wide)	(Aluminium alloy rim)	06824	127,00
<input type="checkbox"/> 4" Active Sport (narrow)	(Aluminium alloy rim)	01398	127,00
<input type="checkbox"/> 4" Active Soft (wide)	(Aluminium alloy rim)	03943	127,00
<input type="checkbox"/> 5" Active Soft (wide)	(Aluminium alloy rim)	07518	127,00
<input type="checkbox"/> 5" Pneumatic		10844	63,00

Date	Order	User	Address
------------	-------------	------------	---------------

Rear wheels			
<input checked="" type="checkbox"/> 24" Ultra-light Progeo - Standard!			
<input type="checkbox"/> 22" Ultra-light Progeo - Standard!			
<input type="checkbox"/> 25" Ultra-light Progeo - Standard!		(colour: black)	
<input type="checkbox"/> 26" Progeo - Standard!		(colour: black)	
<input type="checkbox"/> 24" ULTRA-LIGHT PROGEO KEY SPORT		Weight reduction approx. 450gr.	04383 791,00
<input type="checkbox"/> 24" Ultra-light "Spinergy LX"			01685 791,00
<input type="checkbox"/> 24" Ultra-light "Spinergy LXL"			07846 791,00
<input type="checkbox"/> 24" Ultra-light "Spinergy Flex rim"	<input type="checkbox"/> Black hub and white spokes	<input type="checkbox"/> Hub and spokes black	02270 1.266,00
<input type="checkbox"/> 25" Ultra-light "Spinergy LX"		Integrated aluminium/rubber handrim	02101 791,00
<input type="checkbox"/> 25" Ultra-light "Spinergy LXL"	<input type="checkbox"/> Black hub and white spokes		07847 791,00
<input type="checkbox"/> 26" Ultra-light "Spinergy LX"			02102 791,00
<input type="checkbox"/> 24" Off-road (aluminium handrim black)			01392 264,00

Rear wheel tyre			
<input checked="" type="checkbox"/> High pressure tyre	(22"-24"-25"-26")		
<input type="checkbox"/> High pressure profile tyre	(24")		
<input type="checkbox"/> Marathon Plus	(24"-25")	with anti-puncture protection	01669 69,00
<input type="checkbox"/> Anti-puncture - Colour Black	(24")		11083 116,00
Not available with Rear wheels : 24" ULTRA-LIGHT PROGEO KEY SPORT, 24" Ultra-light "Spinergy LXL"			
<input type="checkbox"/> Anti-puncture - Colour Grey	(22")		04181 116,00

Handrim			
	Wheel distance <input checked="" type="checkbox"/> 3 cm	<input type="checkbox"/> 4 cm	
<input checked="" type="checkbox"/> Aluminium	(22"-24"-25"-26")		
<input type="checkbox"/> Aluminium black SOFT-TOUCH	(24"-25")	(24" handrim, on 25" wheel is installed with spacers)	09170 116,00
<input type="checkbox"/> Chromed Steel	(24"-25")	(24" handrim, on 25" wheel is installed with spacers)	01684 179,00
<input type="checkbox"/> Titanium	(24"-25")	(24" handrim, on 25" wheel is installed with spacers)	00016 285,00
<input type="checkbox"/> Ultra Grepp	(24"-25")	(24" handrim, on 25" wheel is installed with spacers)	00017 317,00
<input type="checkbox"/> Max Grepp	(24"-25")	(24" handrim, on 25" wheel is installed with spacers)	00834 348,00
<input type="checkbox"/> Ergo Para	(24")		00632 348,00
<input type="checkbox"/> TOP FRICTION	(24"-25")	(24" handrim, on 25" wheel is installed with spacers)	11023 306,00
Oval countour with a rubber insert			
<input type="checkbox"/> NOVA H	(24"-25")	(24" handrim, on 25" wheel is installed with spacers)	11025 285,00
Ergonomic black profile			
<input type="checkbox"/> NOVA D	(24"-25")	(24" handrim, on 25" wheel is installed with spacers)	11026 306,00
Ergonomic profile with rubber coating (ideal for quadriplegics)			
<input type="checkbox"/> SURGE LT	(25")	Oval countour with a rubber insert	06427 338,00
<input type="checkbox"/> Quad (24")	(24")		00693 211,00
<input type="checkbox"/> Silicon cover for standard aluminium handrim		Available for measures (22" - 24" - 26")	04050 179,00

Wheel locks			
<input checked="" type="checkbox"/> Bent lever push to lock			
<input type="checkbox"/> Straight lever push to lock			
<input type="checkbox"/> Straight lever pull to lock			
<input type="checkbox"/> Brake with extension lever push to lock			
<input type="checkbox"/> Brake with extension lever pull to lock			

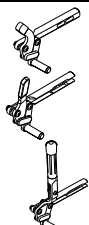

01949	74,00
03372	74,00

Footplate - See reference tables N°3			
<input checked="" type="checkbox"/> Automatic Closure footplate rake and depth adjustable	<input type="checkbox"/> Internal <input checked="" type="checkbox"/> 2/3 Internal <input type="checkbox"/> External		
Minimum footplate distance 32,5cm, calculated with the standard configuration and with the footplates positioned on inside.			
<input type="checkbox"/> Minimum footplate distance 25cm. Available only with Multi-function and rotative system -	03945	190,00	
<input type="checkbox"/> One piece footplate - Flip-up! rake and depth adjustable	<input type="checkbox"/> Internal <input checked="" type="checkbox"/> 2/3 Internal <input type="checkbox"/> External		
Minimum footplate distance 32,5cm, calculated with the standard configuration and with the footplates positioned on inside.			
<input type="checkbox"/> Minimum footplate distance 26cm. Available only with Multi-function and rotative system -	03945	190,00	
<input type="checkbox"/> One piece aluminium footplate - Flip-up! rake and depth adjustable	<input type="checkbox"/> Internal <input checked="" type="checkbox"/> 2/3 Internal <input type="checkbox"/> 2/3 External <input type="checkbox"/> External		
Minimum footplate distance 32,5cm, calculated with the standard configuration and with the footplates positioned on inside.			
<input type="checkbox"/> Plastic footrest rake adjustable	<input checked="" type="checkbox"/> 2/3 Internal <input type="checkbox"/> 2/3 External		
Minimum footplate distance 34 cm, calculated with the standard configuration and with the footplates positioned on inside.			
Weight increase approx. 500gr.			
Need a stretch calf band.			
<input type="checkbox"/> Footplate COMPACT, automatic Closure, rake and depth adjustable	<input checked="" type="checkbox"/> Internal <input type="checkbox"/> External		
Minimum footplate distance 35cm.			
<input type="checkbox"/> One piece Carbon fibre footplate rake adjustable, swing away, flip-up.	<input checked="" type="checkbox"/> Internal <input type="checkbox"/> External		
Minimum footplate distance 32,5cm, calculated with the standard configuration and with the footplates positioned on inside.			

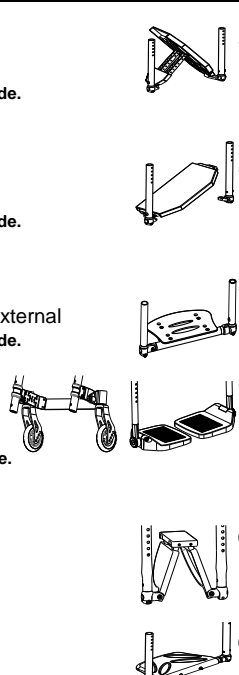





11526	
11527	
11528	
11525	
09957	232,00
03291	285,00



Date	Order	User	Address
------------	-------------	------------	---------------

Mudguard			
☆ ABS mudguard			
<input type="checkbox"/> Straight sideguard			
<input type="radio"/> Carbon fibre mudguard		03946	306,00
<input type="radio"/> Extra charge for REMOVABLE VERSION		03960	116,00

Armrests			
<input type="radio"/> Tubular armrests	(Swing away, removable and height adjustable armrest)		00694 264,00

Accessories			
<input type="radio"/> Pad for front frame protectors		07058	53,00
<input type="radio"/> Backrest-seat connection cloth		10241	21,00
<input type="radio"/> Removable storage bag (with quick coupling)		09811	127,00

Optional 1			
<input type="radio"/> Transit wheels			00836 179,00
<input type="radio"/> Anti-tipper with rapid hookup	(inside rotation to reduce the encumbrance)		
	<input type="radio"/> Right		00023 137,00
	<input type="radio"/> Left		00024 137,00
<input type="radio"/> Tipping aid	<input type="radio"/> Right		00025 95,00
	<input type="radio"/> Left		01046 95,00
<input type="radio"/> Crutches support	<input type="radio"/> Right		00838 84,00
	<input type="radio"/> Left		00837 84,00

Optional 2			
<input type="radio"/> Tetraclip	(Quick release axle for quadriplegic)		03947 179,00
<input type="radio"/> Safety pelvic belt			03972 74,00
<input type="radio"/> Harness			04103 137,00
<input type="radio"/> Push handles for companion	(Removable and height adjustable)		01048 200,00
<input type="radio"/> Quick release front forks			00030 179,00
<input type="radio"/> Lumbar support	(to insert in the backrest upholstery)		00013 53,00
<input type="radio"/> Swing away lateral support	<input type="radio"/> Right		02097 264,00
Not available with Posture backrest PHYSIO	<input type="radio"/> Left		02098 264,00
<input type="radio"/> Spoke guards Black	(22"-24")		01043 169,00
<input type="radio"/> Spoke guards Transparent	(22"-24")		00835 169,00
<input type="radio"/> Spoke guards Progeo design	(22"-24")		00019 190,00
<input type="radio"/> Spoke guards Dragon	(22"-24")		02106 190,00







Additional Kit			
<input type="radio"/> 24" Off-road rear wheels	Off-Road tyre - aluminium handrim (black colour)	03378	528,00
<input type="radio"/> 24" FAT rear wheels	FAT tyre 3" - aluminium handrim (black colour)	09357	897,00

Date Order User Address

PHYSIO - Posture backrest
(Std. Backrest upholstery not provided)



Removable with quick release
Suitable for tubes with diameter 18±26mm
Depth adjustment (4cm)
Angle adjustment (±18°)

AIR Carbon shell

BACKREST HEIGHT	28	34	40			
Shell's shape  7,5 cm	Lateral retaining wing A=high - R=regular					
	A	R	A	R	A	R
						
	<input type="checkbox"/>	<input type="checkbox"/>	<input type="checkbox"/>	<input type="checkbox"/>	<input type="checkbox"/>	<input type="checkbox"/>

886,00

POSTURE Aluminum shell

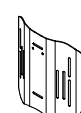
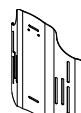
BACKREST HEIGHT	34	40	52			
Shell's shape  7,5 cm	Lateral retaining wing B=regular					
	R	R	R			
						
	<input type="checkbox"/>	<input type="checkbox"/>	<input type="checkbox"/>			

855,00

Configuration DEEP with side support PAD (height adjustable)

C Alluminum lateral with padded, breathable upholstery.



Small (h 13cm)



Right
10272

42,00



Left
10272

42,00

Large (h 20cm)



Right
10273

53,00



Left
10273

53,00

SWING AWAY - Lateral support

Fixing and adjustment hardware complete with protection sleeve
Alluminum lateral with padded, breathable upholstery.

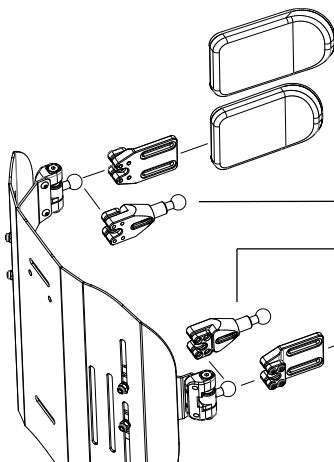

Large (18x12)

05647 179,00

Small (14x9)

05643 179,00

Lateral support extension

Quantity (number pcs).....

10271 63,00

Lateral support extension

Quantity (number pcs).....

Small (14x9)

05642 179,00

Large (18x12)

05646 179,00

Headrest adjustable - Double ball mounting system
Available only with backrest Physio
Not available for backrest Physio AIR carbon shell

Large (34x14)

05648 380,00

Small (28x14)





Date	Order	User	Address
------------	-------------	------------	---------------

Note

Wheelchair : Progeo YOGA - Rev. 2023.2	Prices - VAT excluded to be added to the price list	<table border="1" style="width:100%; border-collapse: collapse;"> <tr> <td colspan="2" style="text-align: center; padding: 2px;">Send this page only if any optional have been chosen</td> </tr> <tr> <td style="width:10%; text-align: center; padding: 2px;">☆</td> <td style="padding: 2px;">standard <small>(supplied if no requests are indicated)</small></td> </tr> <tr> <td style="text-align: center; padding: 2px;">□</td> <td style="padding: 2px;">on request <small>(without extra charge)</small></td> </tr> <tr> <td style="text-align: center; padding: 2px;">○</td> <td style="padding: 2px;">optional <small>(cost to be added at the basic price)</small></td> </tr> </table>	Send this page only if any optional have been chosen		☆	standard <small>(supplied if no requests are indicated)</small>	□	on request <small>(without extra charge)</small>	○	optional <small>(cost to be added at the basic price)</small>
Send this page only if any optional have been chosen										
☆	standard <small>(supplied if no requests are indicated)</small>									
□	on request <small>(without extra charge)</small>									
○	optional <small>(cost to be added at the basic price)</small>									

REFERENCE TABLES

1		Front height			
FORK		Casters			
		3"	4"	5"	6"
SMALL 	min	43	44	46	
	max	44	45		
MEDIUM 	min	46	46	46	46
	max	47	48	49	51
LONG 	min	49	49	49	49
	max	50	51	52	53

The size of the fork will be defined only by Progeo in accordance with wheelchair final configuration.

2		Rear height			
		Rear wheels			
		22"	24"	25"	26"
H min		min. 40	min. 41	min. 42	min. 43
H max		max 47	max 49	max 50	max 51

3		Footplate option	Footplate distance	
		Automatic Closure footplate	min. 32,5	min. 32,5
		One piece footplate - Flip-up!	min. 32,5	min. 32,5
		One piece footplate - Flip-up!... with multifunction rotative system	min. 27,5	min. 29
		One piece aluminium footplate - Flip-up!	min. 32,5	min. 32,5
		Plastic footrest	min. 34	min. 34
		One piece Carbon fibre footplate	min. 32,5	min. 32,5

Calculated with the standard configuration and with the footplates positioned on inside.
IMPORTANT NOTICE! From the footplate to the floor minimum 4cm !! (Minimum Front height = DP + 4cm)

4		Rear wheels
Model	Features	
22" Ultra-light Progeo - Standard!	(not available in anthracite color) - (aluminium handrim and high pressure tyre)	
24" Ultra-light Progeo - Standard!	(available for all colors)	
24" ULTRA-LIGHT PROGEO KEY SPORT	(silver hub, black rim and 16 spokes)	
24" Ultra-light "Spinergy LX"	(silver hub, black rim and spokes)	
24" Ultra-light "Spinergy LXL"	(black hub and rim, 18 white spokes) - (black hub, rim and 18 spokes)	
24" Ultra-light "Spinergy Flex rim"	(silver hub, black rim and spokes) - (integrated aluminium/rubber handrim - encumbrance reduction up to 3cm. - all tyre)	
24" Off-road	(colour: black) - (aluminium handrim - tyre Off-road)	
25" Ultra-light "Spinergy LX"	(silver hub, black rim and spokes)	
25" Ultra-light "Spinergy LXL"	(black hub and rim, 18 white spokes)	
26" Progeo - Standard!	(colour: black)	
26" Ultra-light "Spinergy LX"	(silver hub, black rim and 18 spokes)	

Wheelchair : Progeo YOGA - Rev. 2023.2