

Rigid frame wheelchair

Date .....

User name .....

Company stamp

Responsible .....

## Carbon fibre frame

### Wheelchair measures

Seat width (LS)      33      36      39      42      45      48

The seat width is measured from the outer sides of the frame, while the distance between the two side guards is 1 cm wider.

Seat depth (PS)      35      37,5      40      42,5      45      47,5      50

The real seat depth, from the front part of the seat cloth to the backrest tube will be 1,5 cm more than the declared one.

Footplate distance (DP) ..... (Real distance between seat and footplate)

**IMPORTANT NOTICE! From the footplate to the floor minimum 4cm.!! (Minimum Front height = DP + 4cm.)**

Setting     ☆ Standard      Prudential      Active      Extreme

Backrest Height (TS)     Std.Value 33,5 .....(min 24.5-max 47)

camber     ☆ 0°      2°      4°

Front height STD 49     .....     Rear height STD 42     .....

24" Rear wheel (min 38-max 46)  
 25" Rear wheel (min 39-max 47)  
 26" Rear wheel (min 40-max 48)

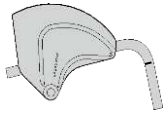

☆ Version mudguard (Available only with rear wheels 24")

Version straight sideguard

### Seat

- ☆ Seat cloth with pocket (under seat)
- Seat with tension straps     **08883     180,00**
- Carbon rigid seat     **08336     380,00**
  - Pocket (under seat) [25x11x4,5]     **08281     60,00**

### STYLE

- ☆ CARBON Essence
- ALA ROSSA     **07947     100,00**
- ALA BIANCA     **07948     100,00**

### Footplate

☆ Carbon fibre footplate - adjustable distance +/- 1,5cm. SPECIAL FLIP-UP!

Minimum footplate distance 35cm.

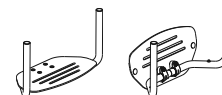

Rehateam s.r.l. - Vicolo Negrelli, 5 - 31040 Castagnole di Paese (TV) - Tel. +39.0422.484657 / +39.0422.480387 - Fax +39.0422.484661 / +39.0422.484684  
 P.IVA IT 03182520266 - C.C.I.A.A. TV n.225867 - Iscr.Trib. TV n.41690 Capitale Sociale I.V. Euro 100.000,00

Email: info@rehteamprogeo.com - web: http://www.rehteamprogeo.com

Date     
  Order     
 English User name     
 Address

### Backrest adjustment and fixing system

- Backrest with double locking (upright and folded) with rake adjustable from -4° to +16°
- Backrest with upright locking system ONLY (no locking when folded) with rake adjustable from -4° to +16°
- Fixed back(non-folding back) with rake adjustable from -4° to +16°

### Backrest

Adjustable velcro straps and padded transpiring upholstery

Aluminium backrest

Titanium backrest

Carbon fibre backrest

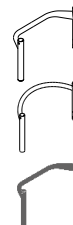

06811

150,00

04389

600,00

**AIR** Integrated posture backrest (NOT REMOVABLE)

Carbon shell - Lateral retaining 7,5cm  
 Depth adjustment ±1cm. - Angle adjustment ±10°  
 not available for seat width 48

840,00

#### Installation on:

Backrest tube

Aluminium backrest

Titanium backrest

Carbon fibre backrest



06811

150,00

04389

600,00

H 28		H 34		H 40	
Backrest Height (TS) min 34		Backrest Height (TS) min 38		Backrest Height (TS) min 44	
( ..... )		( ..... )		( ..... )	
Lateral retaining wing A=high - R=regular					
A	R	A	R	A	R
<input type="checkbox"/>	<input type="checkbox"/>	<input type="checkbox"/>	<input type="checkbox"/>	<input type="checkbox"/>	<input type="checkbox"/>

### Handle tube

Handle tube STD

Handle tube with short tubes

Handle tube SPORT Without push handles

Carbon fibre handle (with short tubes) (Lightest configuration)

04390

120,00

**Not available with: Posture backrest PHYSIO - Posture backrest A I R**

Folding handles aluminium



02958

200,00

### Casters

4" Soft

3" Sport

(Lightest configuration)

5" Soft

3" Active Soft (wide)

(Aluminium alloy rim)

06824

100,00

4" Active Sport (narrow)

(Aluminium alloy rim)

01398

100,00

4" Active Soft (wide)

(Aluminium alloy rim)

03943

100,00

5" Active Soft (wide)

(Aluminium alloy rim)

07518

100,00

5" Pneumatic

10844

50,00

English

Date ..... Order ..... User name ..... Address .....

### Rear wheels

Available with : VERSION MUDGUARD - VERSION STRAIGHT SIDEGUARD

☆ 24" Ultra-light Progeo - Standard!				
<input type="radio"/> 24" ULTRA-LIGHT PROGEO KEY SPORT	(Lightest configuration)		04383	700,00
<input type="radio"/> 24" Ultra-light "Spinergy LX"			01685	700,00
<input type="radio"/> 24" Ultra-light "Spinergy LXL"	<input type="checkbox"/> Black hub and white spokes	<input type="checkbox"/> Hub and spokes black	07846	700,00
<input type="radio"/> 24" Off-road (aluminium handrim black)			01392	180,00
<b>Available only with: VERSION STRAIGHT SIDEGUARD</b>				
<input type="checkbox"/> 22" Ultra-light Progeo - Standard!				
<input type="checkbox"/> 25" Ultra-light Progeo - Standard!	(colour: black)			
<input type="checkbox"/> 26" Progeo - Standard!	(colour: black)			
<input type="radio"/> 25" Ultra-light "Spinergy LX"			02101	700,00
<input type="radio"/> 25" Ultra-light "Spinergy LXL"	<input type="checkbox"/> Black hub and white spokes		07847	700,00
<input type="radio"/> 26" Ultra-light "Spinergy LX"			02102	700,00

### Rear wheel tyre



☆ High pressure tyre	(22"-24"-25"-26")	(Lightest configuration)		
<input type="checkbox"/> High pressure profile tyre	(24")			
<input type="radio"/> Marathon Plus	(24"-25")	with anti-puncture protection	01669	50,00
<input type="radio"/> Anti-puncture - Colour Grey	(22")		04181	80,00
<input type="radio"/> Solid tyre Kik Mako - Colour Black	(24")		01041	100,00
<input type="radio"/> Solid tyre Kik Mako - Colour Grey	(24")		01751	100,00

### Handrim - Wheel distance

☆ 3 cm       4 cm

☆ Aluminium	(22"-24"-25"-26")	(Lightest configuration)		
<input type="radio"/> Aluminium black SOFT-TOUCH	(24"-25")	(24" handrim, on 25" wheel is installed with spacers)	09170	100,00
<input type="radio"/> Chromed Steel	(24"-25")	(24" handrim, on 25" wheel is installed with spacers)	01684	120,00
<input type="radio"/> Titanium	(24"-25")	(24" handrim, on 25" wheel is installed with spacers)	00016	220,00
<input type="radio"/> Ultra Grepp	(24"-25")	(24" handrim, on 25" wheel is installed with spacers)	00017	250,00
<input type="radio"/> Max Grepp	(24"-25")	(24" handrim, on 25" wheel is installed with spacers)	00834	280,00
<input type="radio"/> Ergo Para	(24")		00632	280,00
<input type="radio"/> SURGE LT	(24"-25")	Oval countour with a rubber insert	06427	290,00
<input type="radio"/> Quad (24")	(24")		00693	160,00
<input type="radio"/> Silicon cover for standard aluminium handrim		Available for measures (22" - 24" - 26")	04050	130,00

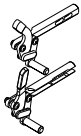
### Wheel locks

☆ Without brake	(Lightest configuration)			
<input type="checkbox"/> Bent lever push to lock				
<input type="checkbox"/> Straight lever Push to lock				
<input type="checkbox"/> Straight lever Pull to lock				
<input type="radio"/> Sport brake			06428	100,00
<input type="radio"/> Brake with extension lever push to lock			01949	50,00
<input type="radio"/> Brake with extension lever pull to lock			03372	50,00



### Armrests

<input type="radio"/> Swing away armrests	(Swing away, removable and height adjustable armrest)		00694	200,00
☆ Pad STANDARD				
<input type="radio"/> Ergonomic pad (30x6 cm.)			04104	50,00

### Accessories

<input type="radio"/> Pad for front frame protectors			07058	40,00
<input type="radio"/> Backrest-seat connection cloth			10241	15,00
<input type="radio"/> Removable storage bag (with quick coupling)			09811	100,00

### Optional 1

<input type="radio"/> Transit wheels			03290	120,00
<input type="radio"/> Anti-tipper with rapid hookup	(inside rotation to reduce the encumbrance)			
<input type="radio"/> Right			06821	100,00
<input type="radio"/> Left			06822	100,00

Date ..... Order ..... English User name ..... Address .....



<b>Optional 2</b>			
<input type="checkbox"/> Lumbar support	(to insert in the backrest upholstery)	00013	<b>30,00</b>
<input type="checkbox"/> Tetraclip	(Quick release axle for quadriplegic)	03947	<b>140,00</b>

<b>Additional Kit</b>			
<input type="checkbox"/> 24" Off-road rear wheels	Off-Road tyre - aluminium handrim (black colour)	03378	<b>400,00</b>
<input type="checkbox"/> 24" FAT rear wheels	FAT tyre 3" - aluminium handrim (black colour)	09357	<b>700,00</b>

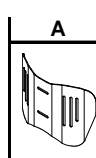

**PHYSIO - Posture backrest - Std. Backrest upholstery not provided**

Removable with quick release  
Suitable for tubes with diameter 18÷26mm  
Depth adjustment (4cm)  
Angle adjustment (±18°)

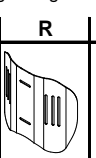
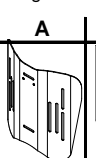
**AIR** Carbon shell  
not available for seat width 48

<b>BACKREST HEIGHT</b>	<b>28</b>	<b>34</b>	<b>40</b>	<b>840,00</b>		
Shell's shape	Lateral retaining wing A=high - R=regular					
						

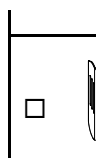
**POSTURE** Aluminum shell

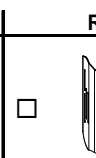
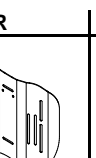
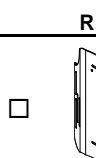
<b>BACKREST HEIGHT</b>	<b>34</b>	<b>40</b>	<b>52</b>	<b>810,00</b>		
Shell's shape	Lateral retaining wing B=regular					
						

**Configuration DEEP with side support PAD (height adjustable)**

Aluminum lateral with padded, breathable upholstery.



Small (h 13cm)



Right  
10272

**25,00**

Left  
10272

**25,00**

Large (h 20cm)



Right  
10273

**30,00**

Left  
10273

**30,00**

**SWING AWAY - Lateral support**

Fixing and adjustment hardware complete with protection sleeve  
Aluminum lateral with padded, breathable upholstery.

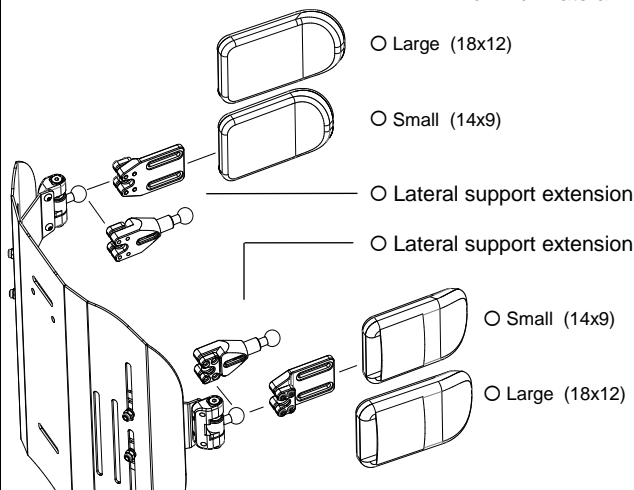

Large (18x12)

05647 **150,00**

Small (14x9)

05643 **150,00**

Lateral support extension

Quantity (number pcs).....

10271 **55,00**

Lateral support extension

Quantity (number pcs).....

Small (14x9)

05642 **150,00**

Large (18x12)

05646 **150,00**

Rehateam s.r.l. Vicolo Negrelli, 5 - 31040 Castagnole di Paese (TV) - Tel. +39.0422.484657 / +39.0422.480387 - Fax +39.0422.484661 / +39.0422.484684  
P.IVA IT 03182520266 - C.C.I.A.A. TV n.225867 - Iscr.Trb. TV n.41690 Capitale Sociale I.V. Euro 100.000,00

Email: info@rehateamprogeo.com - web: http://www.rehateamprogeo.com

Date .....	Order .....	English User name .....	Address .....
------------	-------------	----------------------------	---------------

<input type="radio"/> Headrest adjustable - Double ball mounting system <b>Available only with backrest Physio</b> <b>Not available for backrest Physio AIR carbon shell</b>			
<input type="checkbox"/> Large (34x14) <b>05648    200,00</b> <input type="checkbox"/> Small (28x14)			

Rehateam s.r.l. Vicolo Negrelli, 5 - 31040 Castagnole di Paese (TV) - Tel. +39.0422.484657 / +39.0422.480387 - Fax +39.0422.484661 / +39.0422.484684  
 P. IVA IT 03182520266 - C.C.I.A.A. TV n.225667 - Iscr. Trib. TV n.41690 Capitale Sociale I.V. Euro 100.000,00

Email: info@rehateamprogeo.com - web: http://www.rehateamprogeo.com