

AI
ALUMINIUM 7020



CE

Customer Contact Details

Customer Name: _____

RGK Genius: _____

Address: _____

Phone: _____

Email: _____

Ship to Customer Address:

Shipping Name: _____

Shipping Address: _____

Phone: _____

Email: _____

Additional Information

Notes: _____

Current Wheelchair: _____

Customer Weight: _____

Customer Height: _____

Customer Disability: _____

Other

VAT Exemption Declaration (UK Only):

I declare that I am chronically sick or disabled by reason of:

and that I am receiving from RGK Wheelchairs Ltd, the wheelchair specified herein and I claim relief from Value Added Tax under group 12 of schedule 8 to Value Added Tax Act 1994.

Signature: _____ Date: _____

RGK Contact Authorisation:

From time to time, RGK would like to send you exclusive information, news and offers on everything RGK, by email or post. We will not pass any of your details to any third party.

I would like to be contacted by RGK:

Signature: _____ Date: _____

Guide: Base product Required option Optional Extra Critical Information Information Needed

PRODUCT STYLE

GCAZX011 GRAND SLAM CX
\$6,556.00

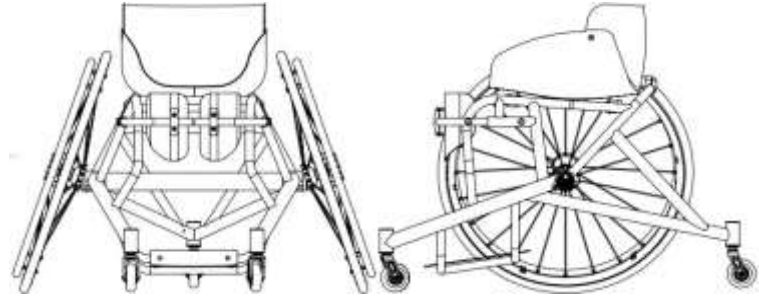

Max User Weight 125kg (275lbs)

CAD APPROVAL

XW010 Full CAD drawing for approval
\$169.00

KEY FRAME MEASUREMENTS

XY010 Seat width (*Inside to inside of sideguards*)
 (Max - 390mm)
(Min=270mm)

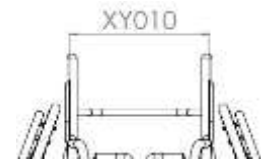

Select CX shell width (optional)

- A-330mm XY010 = 270-315 C-380mm XY010 = 320-365
 B-355mm XY010 = 295-340 D-405mm XY010 = 345-390

Note: CX Shell Seat Taper

Seat Taper	Seat length (mm)				
	250	300	350	400	
330	305	280	255	230	
355	330	305	280	255	
380	355	330	305	280	
405	380	355	330	305	

Hard foam will be used to get Seat width

XY020 Seat length
 (Max - 500mm)

XY030 Extra seat length
(Provides additional leg support & hand grip, N/R with Knee Support)

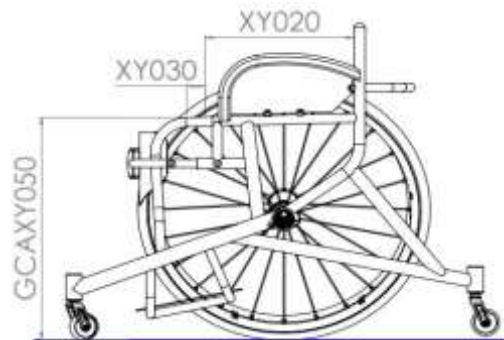

GCAXY050 Front seat height (*Floor to middle of seat without cushion*)
 (Max - 630mm)
(Min - 360mm)

GCAXY060 Rear seat height (*Floor to middle of seat without cushion*)
 (Max - 630mm)
(Min - 360mm)

XY070 Frame length
 (Min = XY020 + XY030 + 140mm)

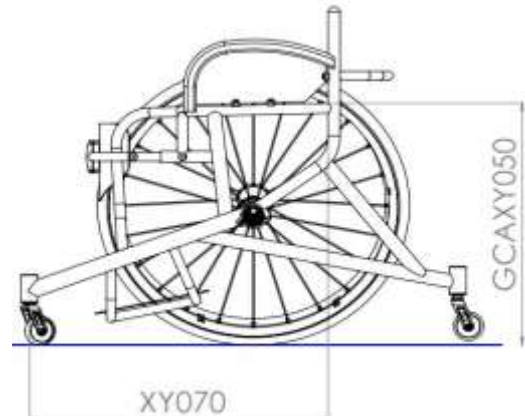

FRONT FRAME

XY080 Seat taper design

i Specify taper width
 mm



Knee support options

XA200 Knee support ratchet system
 (Tubes on the **outside** as std)

i Specify length
 mm

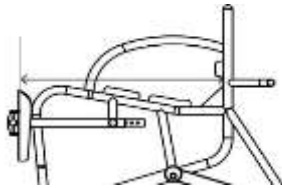

XA203 Carbon fibre shin pads
 \$298.00 (Includes 7mm hard padding)

XA204 Extra padding for shin pads
 \$73.00

i Specify padding thickness
 mm

Specify padding density

Medium Hard

FOOTREST

Footrest Type

GCAXB080 Fixed position footrest

Footrest Measurements

Front footrest height
 mm (min = 35mm)



Footrest width
 mm (Std= 200mm)

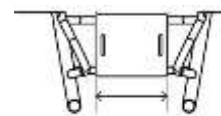

Rear footrest height
 mm (min = 35mm)

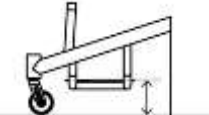

Footrest length
 mm (Std = 250mm)

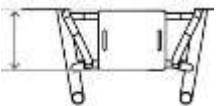

Footrest position
 (front of footplate to castor pot)
 mm

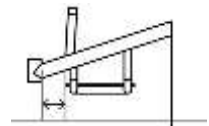

Footrest Plate

XB190 Carbon fibre footplate
 \$192.00

XB100 ABS moulded foot tray
 \$113.00

GCAXB140 Spacer kit
 \$16.00 (Allows for 25mm increase in height)

i Specify length
 mm Max = 380mm (Full)
 Std = 330mm

Footrest Plate Options

XB240 Aluminium raised edges
 \$66.00 (Cost per Edge)

Front Back Left Right

Specify height
 (Max = 60mm)

XB250 Carbon Fibre raised edge
 \$254.00 (1 side only)

Front Back

Specify height
 (Max = 45mm)

Castor Pin Width

XY330 Castor pin width

! mm Optimise measurements

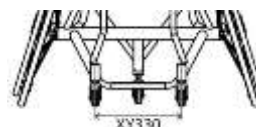

CAMBER BAR AND ANTI-TIP

Centre of Gravity and Camber Angle

GCAXY510 Fixed centre of gravity

Specify measurement  mm



XY390 Camber angle

 16 18 20 22

Anti-tip options (Choose one)

GCAXJ040 Single fixed anti tip

Specify distance behind rear wheel mm (Std = 100mm)



SIDEGUARDS

Sideguard Measurements

Sideguard height (std = 150mm)(follow tyre)(Max = 180)

 mm

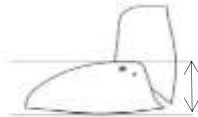

Backrest depth (std = 150mm)(Max =)

 mm

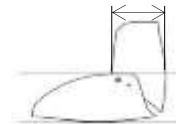

Individual Shape

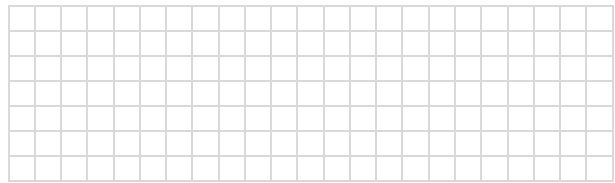
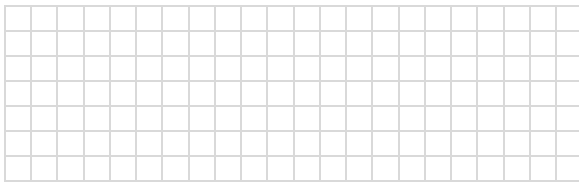

BACKREST

Backrest Height (Choose One)

XY230 Fixed backrest height

Specify height  mm

Backrest depth **top** (distance from front of back post to middle of upholstery)

mm

Backrest depth **bottom** (distance from front of back post to middle of upholstery)

mm

Note: Take measurement from existing chair

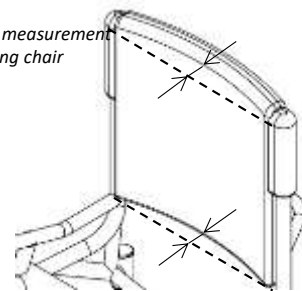

CASTOR AND REAR WHEELS

Castor Options

- | | |
|--|--|
| <input type="checkbox"/> XC160 Sport 61mm castor
(Std, Black) | <input type="checkbox"/> XC181 Bones Reds bearings
(All castor bearings) |
| <input type="checkbox"/> XC170 Sport 72mm castor
(Black) | <input type="checkbox"/> XC182 Bones Swiss Ceramic bearings
(All castor bearings)
\$243.00 |

Rear Wheel Size

- | | | | |
|---|---|---|--|
| <input type="checkbox"/> XY420 24" Wheels | <input type="checkbox"/> XY430 25" Wheels | <input type="checkbox"/> XY440 26" Wheels | <input type="checkbox"/> XY450 700C Wheels |
|---|---|---|--|

Rear Wheel Gap

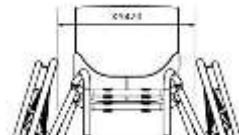
<input type="checkbox"/> XY460 Rear wheel gap		<input type="checkbox"/> XY470 Inside to inside of wheel	
<input type="checkbox"/> 15 <input type="checkbox"/> 20 <input type="checkbox"/> 25 <input type="checkbox"/> 30 Individual <input type="text" value=""/> mm	OR	<input type="text" value=""/> mm	

Rear Wheel Options

- | | |
|---|---|
| <input type="checkbox"/> XK080 Spinergy SLX 24 spoke
\$624.00 | <input type="checkbox"/> XK521 Spinergy Ceramic bearing upgrade
\$220.00 |
| <input type="checkbox"/> XK100 Spinergy XSLX 24 spoke
\$719.00 | |

Spinergy Colour Options: 

- | | | | |
|--|--|--|--|
| <input type="checkbox"/> Black spokes | <input type="checkbox"/> White spokes | <input type="checkbox"/> Yellow spokes | <input type="checkbox"/> XK180 Individual spoke design
\$153.00
(Specify colour) |
| <input type="checkbox"/> Red spokes | <input type="checkbox"/> Blue spokes | <input type="checkbox"/> Pink spokes | Inside: _____ |
| <input type="checkbox"/> Purple spokes | <input type="checkbox"/> Orange spokes | <input type="checkbox"/> Green spokes | Outside: _____ |

Spinergy Anodise Options

- | | | | |
|--|--|--|--|
| <input type="checkbox"/> XK190 Black hub
(std option) | <input type="checkbox"/> XK200 Silver hub
\$80.00 | <input type="checkbox"/> XK201 Red hub/rims
\$162.00 | <input type="checkbox"/> XK205 Individual hub/rims
\$213.00
Select colour: _____ |
| <input type="checkbox"/> XK202 Purple hub/rims
\$162.00 | <input type="checkbox"/> XK203 Blue hub/rims
\$162.00 | <input type="checkbox"/> XK204 Gold hub/rims
\$213.00 | |

Supply Without Wheels

- | | | |
|---|--|---------------------------------|
| <input type="checkbox"/> XK040 Supply without Wheels
-\$161.00 |  Wheel Type: <input type="text"/> | Tyre Type: <input type="text"/> |
|---|--|---------------------------------|

Handrim Position / Options

- | | |
|---|---|
| <input type="checkbox"/> XY480 Narrow set handrim | <input type="checkbox"/> XY485 Wide set handrim |
| <input type="checkbox"/> XL090 Remove excess mounting tabs
\$89.00
(recommended for small wheel gaps) | |

Handrim Style

- | | |
|---|--|
| <input type="checkbox"/> XL010 Aluminium hard anodised 6 tab | <input type="checkbox"/> XL040 Titanium 6 tab
\$210.00
(Not with 700C) |
| <input type="checkbox"/> XL130 Aluminium hard anodised 6 tab Painted
\$58.00
(Select Colour) <input type="text"/> | <input type="checkbox"/> XL100 Para grip 6 tab (Not with 700C)
\$248.00
(700C not available) |
| <input type="checkbox"/> XL070 Aluminium hard anodised 12 tab
\$89.00
(24" not available) | <input type="checkbox"/> XL020 Tetra Grip 6 tab
\$248.00 |

Tyre Options

- | | |
|--|---|
| <input type="checkbox"/> XM070 Kenda Kaliente <input type="checkbox"/> Red <input type="checkbox"/> Blue | <input type="checkbox"/> XM080 Tufo MS3 tubeless
\$72.00
(Blue only) |
| <input type="checkbox"/> XM150 IRC Exeracer Pro
\$72.00
(Red Only) | <input type="checkbox"/> XM090 Tufo WS3 tubeless
\$72.00
(24" only and Blue only) |

Spare Wheel

- | | |
|--|---|
| <input type="checkbox"/> GCAXK500 Spare wheel Spinergy
\$738.00
(All inclusive + axle pin) | <input type="checkbox"/> XK520 Spare wheel Titanium / Super narrow upcharge
\$118.00 |
|--|---|

Inner Tube Valve Options

- | | |
|---|--|
| <input type="checkbox"/> XY500 Schraeder inner tube valve  | <input type="checkbox"/> XY490 Presta inner tube valve
(Standard if no option selected)  |
|---|--|

FINISH OPTIONS

Frame finish

XN010 Powder coated frame

Frame **Gloss**

- Black gloss 103
- White gloss 100
- Grey gloss 132
- Cream gloss 135
- Red gloss 108
- Yellow gloss 120
- Forest green gloss 143
- Green gloss 107
- Dark blue gloss 151
- Royal blue gloss 154
- Blue gloss 174
- Duckegg blue gloss 141
- Pink gloss 188
- Orange gloss 180
- Purple gloss 157

Frame **Matt**

- Black matt 105
- White matt 101
- Grey matt 131
- Light grey matt 133
- Navy blue matt 152

Frame **Special**

- Chrome Mirror 300
- Sparkle silver 170
- Metallic black matt 104
- Metallic grey matt 130
- Black sandpaper 201
- Grey sandpaper 202
- White sandpaper 200

XN200 Individual paint colour (State Colour/RAL code)
\$150.00

GCAXN030 Brushed frame
\$304.00

GCAXN050 Polished frame
\$803.00

Accent Colour

Note: Accent colour includes, forks, castor caps, and logo decals.

- Black accent
- Red accent
- Purple accent

- Silver accent
- Blue accent
- Carbon accent
(caps only, otherwise black)

XN250 Individual accent
\$150.00

Select Colour:

UPHOLSTERY AND CUSHION

CX Options



XP200

CX seat and backrest upholstery

Seat cushion foam thickness

7mm
 10mm
 25mm
 50mm
 Custom thickness

Backrest foam thickness

7mm
 10mm
 25mm
 50mm
 Custom thickness

Indicate Max Height:

580mm
 630mm

Seat cushion foam type

Soft
 Med
 Hard
 Plastazote

Backrest foam type

Soft
 Med
 Hard
 Plastazote

STRAPPING

Velcro straps



XS050

100mm Pro adjustable velcro strap

\$104.00



XS055

50mm Pro adjustable velcro strap

\$104.00



XS057

50mm Pro adjustable velcro **Knee** strap
(measurement from tube to tube over knees)

\$104.00

Velcro strap position



Strap 1

Type

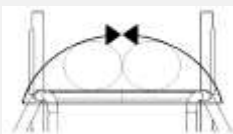

Specify strap length

mm

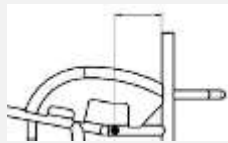

Specify distance from back post

mm



Strap 1

Type

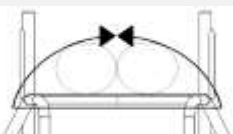

Specify strap length

mm

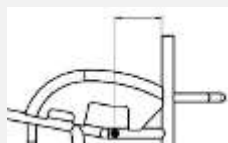

Specify distance from back post

mm

Ratchet Straps



XS020

Sport ratchet strap (Click strap)

\$71.00



XS025

Pelvi Loc 2DA ratchet strap
(For thighs and knees)

\$185.00



Select size:

Medium (8")
 Large (10")



XS030

Pelvi Loc 3DA ratchet strap
(For hips)

\$198.00



Select size:

Small (8")
 Medium (9")
 Large (10")
 Extra Large (11")



XS035

M2 ratchet strap
(For thighs and knees)

\$118.00



8"
 10"
 12"

Ratchet strap position



Strap 1

Type

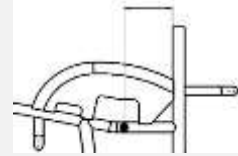

Specify distance from back post

mm



Strap 2

Type

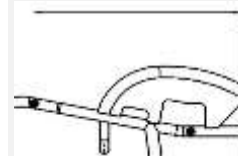

Specify distance from back post

mm



XS040

Fixed mounting points
(one set per click strap)

\$74.00

x1
 x2
 x3

FRAME OPTIONS



XR060

Calf strap mounting loops

\$89.00



XR065

Strap location loops

\$89.00

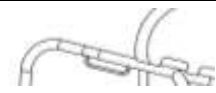

ACCESSORIES



XR030

Triple wheel bag
(Black)

\$87.00



XP130

Frame protectors full length

\$79.00



XS100

Bodypoint waist strap

\$79.00

Small
 Large



XS070

Foot strap (select if required)



XS060

Calf strap (select if required)



XP400

Back bar protector



XR090

Tool kit

NOTES

