

**AI**

ALUMINIUM 7020



CE

**Customer Contact Details**

Customer Name: \_\_\_\_\_

RGK Genius: \_\_\_\_\_

Address: \_\_\_\_\_  
\_\_\_\_\_  
\_\_\_\_\_

Phone: \_\_\_\_\_

Email: \_\_\_\_\_

Ship to Customer Address: 

Shipping Name: \_\_\_\_\_

Shipping Address: \_\_\_\_\_  
\_\_\_\_\_  
\_\_\_\_\_

Phone: \_\_\_\_\_

Email: \_\_\_\_\_

**Additional Information**Notes: \_\_\_\_\_  
\_\_\_\_\_  
\_\_\_\_\_

Current Wheelchair: \_\_\_\_\_

Customer Weight: \_\_\_\_\_

Customer Height: \_\_\_\_\_

Customer Disability: \_\_\_\_\_

**Other****VAT Exemption Declaration (UK Only):**

I declare that I am chronically sick or disabled by reason of:

\_\_\_\_\_  
and that I am receiving from RGK Wheelchairs Ltd, the wheelchair specified herein and I claim relief from Value Added Tax under group 12 of schedule 8 to Value Added Tax Act 1994.

Signature: \_\_\_\_\_ Date: \_\_\_\_\_

**RGK Contact Authorisation:**

From time to time, RGK would like to send you exclusive information, news and offers on everything RGK, by email or post. We will not pass any of your details to any third party.

I would like to be contacted by RGK: 

Signature: \_\_\_\_\_ Date: \_\_\_\_\_

**Guide:**
 Base product

 Required option

 Optional Extra

Critical Information



Information Needed

## PRODUCT STYLE

 **ECAXZ011 ELITE CX**  
**\$6,839.00**

- XY010 Heat treated frame
- ECAXA062 Standard
- ECAXA063 Standard with 25mm seatrail
- ECAXA280 Heavy duty upgrade  
 \$482.00 *(Spinergy R10 wheels also required)*

**Max User Weight 125kg (275lbs)**

## CAD APPROVAL

 XW010 Full CAD drawing for approval  
 \$169.00

## KEY FRAME MEASUREMENTS

 XY010 Seat width *(Inside to inside of sideguards)*

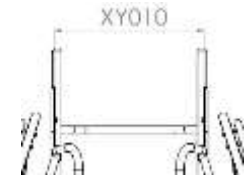
 *(Max - 390mm)*  
*(Min=270mm)*

*Select CX shell width (optional)*

- A-330mm XY010 = 270-315
- C-380mm XY010 = 320-365
- B-355mm XY010 = 295-340
- D-405mm XY010 = 345-390

*Note: CX Shell Seat Taper*

Seat Taper	Seat length (mm)				
	250	300	350	400	
Seat width (mm)	330	305	280	255	230
	355	330	305	280	255
	380	355	330	305	280
	405	380	355	330	305

*Hard foam will be used to get Seat width*
 XY020 Seat length

 *(Max - 500mm)*
 XY030 Extra seat length *(Provides additional leg support & hand grip)*

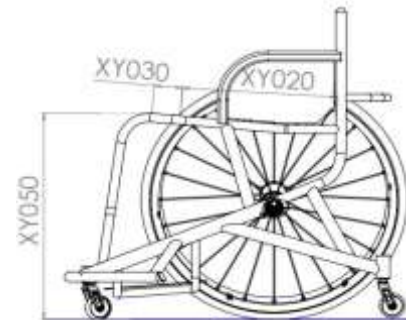

 ECAXY050 Front seat height *(Floor to middle of seat without cushion)*

 *(Max - 630mm)*  
*(Min - 360mm)*
 ECAXY060 Rear seat height *(Floor to middle of seat without cushion)*

 *(Max - 630mm)*  
*(Min - 360mm)*
 XY070 Frame length

 *(Min = XY020 + XY030 + 140mm)*

## FRONT FRAME

XY080 Seat taper design

**i** Specify taper width  
 mm



## FOOTREST

Footrest Type

EXAXB080 Fixed position footrest

ECAXB145 Multi position footrest tubes  
 \$122.00



Footrest Measurements

Front footrest height  
 mm (min = 35mm)



Footrest width  
 mm (Std = 200mm)

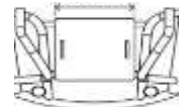

Rear footrest height  
 mm (min = 35mm)



Footrest length  
 mm (Std = 250mm)

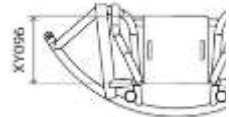

Footrest position  
 (front of footplate to castor pot)  
 mm

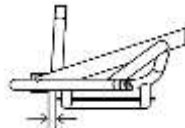

Footrest Plate

XB190 Carbon fibre footplate  
 \$192.00

XB100 ABS moulded foot tray  
 \$113.00

ECAXB140 Spacer kit  
 \$16.00 (Allows for 25mm increase in height)

**i** Specify length  
 mm Max = 380mm (Full)  
 Std = 330mm

Footrest Plate Options

XB240 Aluminium raised edges  
 \$66.00 (Cost per Edge)

Front  Back  Left  Right

Specify height  
 (Max = 60mm)

XB250 Carbon Fibre raised edge  
 \$254.00 (1 side only)

Front  Back

Specify height  
 (Max = 45mm)

Castor Pin Width

XY330 Castor pin width

**!**  mm  Optimise measurements

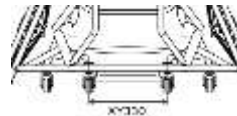

## CAMBER BAR, WING AND ANTI-TIP

Centre of Gravity and Camber Angle

ECAXY510 Fixed centre of gravity



Specify measurement  
 mm

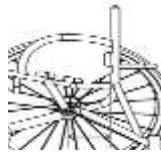

XY390 Camber angle



16  18  20  22

### Wing Options (Choose one)

ECAXA110 Round design basketball wing

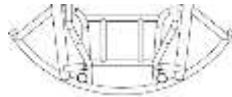

ECAXA125 Arrow design basketball wing  
\$154.00

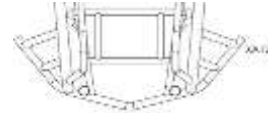

ECAXA120 Straight sided design basketball wing  
\$154.00



### Anti-tip options (Choose one)

ECAXJ040 Single fixed anti tip

ECAXJ060 Double fixed anti tip  
\$217.00

## SIDEGUARDS

Sideguard Measurements

Sideguard height  
(std = 150mm)(follow tyre)(Max = 180)



mm



Backrest depth  
(std = 150mm)(Max = 150)



mm

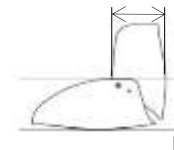

### Individual Shape

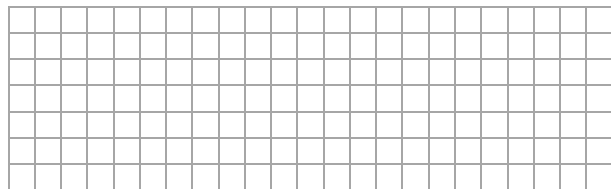
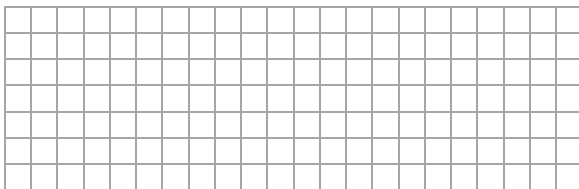

## BACKREST

Backrest Height (Choose One)

XY230 Fixed backrest height



Specify height  
 mm

Backrest depth **top**  
(distance from front of back post to middle of upholstery)

mm

Backrest depth **bottom**  
(distance from front of back post to middle of upholstery)

mm

Note: Take measurement from existing chair

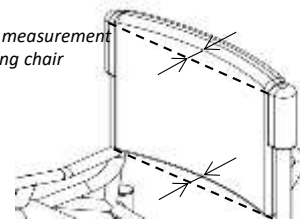

## CASTOR AND REAR WHEELS

### Castor Options

- |   |  |
|---|--|
| <input type="checkbox"/> XC160 Sport 61mm castor<br>(Black) | <input type="checkbox"/> XC181 Bones Reds bearings<br>(All castor bearings)                      |
| <input type="checkbox"/> XC200 Sport micro fork             | <input type="checkbox"/> XC182 Bones Swiss Ceramic bearings<br>(All castor bearings)<br>\$243.00 |

### Rear Wheel Size

- |   |   |   |  |
|---|---|---|--|
| <input type="checkbox"/> XY420 24" Wheels | <input type="checkbox"/> XY430 25" Wheels | <input type="checkbox"/> XY440 26" Wheels | <input type="checkbox"/> XY450 700C Wheels |
|---|---|---|--|

### Rear Wheel Gap

<input type="checkbox"/> XY460 Rear wheel gap		<input type="checkbox"/> XY470 Inside to inside of wheel	
15 <input type="checkbox"/> 20 <input type="checkbox"/> 25 <input type="checkbox"/> 30 <input type="checkbox"/> Individual <input type="text"/> mm	OR	<input type="text"/> mm	

### Rear Wheel Options

- |  |   |
|--|---|
| <input type="checkbox"/> XK080 Spinerger <b>SLX</b> 24 spoke<br>\$655.00               | <input type="checkbox"/> XK330 Spinerger <b>SLX R10</b> heavy duty 24 spoke<br>\$1,211.00<br>(18 deg camber angle only) |
| <input type="checkbox"/> XK101 Spinerger XSLX 24 spoke + Caps<br>\$719.00              | <input type="checkbox"/> XK521 Spinerger Ceramic bearing upgrade<br>\$220.00  |
| <b>Spinerger Colour Options:</b>   |   |
| <input type="checkbox"/> Black spokes  | <input type="checkbox"/> White spokes   |
| <input type="checkbox"/> Red spokes  | <input type="checkbox"/> Blue spokes  |
| <input type="checkbox"/> Purple spokes   | <input type="checkbox"/> Orange spokes  |
| <input type="checkbox"/> Yellow spokes   | <input type="checkbox"/> Pink spokes  |
| <input type="checkbox"/> Green spokes  | <input type="checkbox"/> XK180 Individual spoke design<br>\$153.00<br>Inside: _____<br>Outside: _____                   |
| <input type="checkbox"/> XK190 Black hub<br>(std option)                               | <input type="checkbox"/> XK200 Silver hub<br>\$80.00  |
| <input type="checkbox"/> XK202 Purple hub/rims<br>\$162.00                             | <input type="checkbox"/> XK203 Blue hub/rims<br>\$162.00  |
| <input type="checkbox"/> XK201 Red hub/rims<br>\$162.00                                | <input type="checkbox"/> XK204 Gold hub/rims<br>\$213.00  |
| <input type="checkbox"/> XK205 Individual hub/rims<br>\$213.00<br>Select colour: _____ |   |

### Supply Without Wheels

- |   |                                  |                                 |
|---|----------------------------------|---------------------------------|
| <input type="checkbox"/> XK040 Supply without Wheels<br>-\$161.00 | Wheel Type: <input type="text"/> | Tyre Type: <input type="text"/> |
|---|----------------------------------|---------------------------------|

### Handrim Position / Options

- |   |   |
|---|---|
| <input type="checkbox"/> XY480 Narrow set handrim   | <input type="checkbox"/> XY485 Wide set handrim   |
| <input type="checkbox"/> XL090 Remove excess mounting tabs<br>\$89.00<br>(recommended for small wheel gaps) | <input type="checkbox"/> XL080 Super narrow set handrim<br>\$177.00<br>(only with XL040 and includes XL090) |

### Handrim Style

- |  |  |
|--|--|
| <input type="checkbox"/> XL010 Aluminium hard anodised <b>6 tab</b>                                    | <input type="checkbox"/> XL040 Titanium 6 tab<br>\$210.00<br>(Not with 700C) |
| <input type="checkbox"/> XL070 Aluminium hard anodised <b>12 tab</b><br>\$89.00<br>(24" not available) | <input type="checkbox"/> XL050 Stainless steel 6 tab<br>\$116.00             |

### Tyre Options

- |  |                              |                               |   |
|--|------------------------------|-------------------------------|---|
| <input type="checkbox"/> XM070 Kenda Kaliente                            | <input type="checkbox"/> Red | <input type="checkbox"/> Blue | <input type="checkbox"/> XM080 Tufo MS3 tubeless<br>\$72.00<br>(Blue only)              |
| <input type="checkbox"/> XM150 IRC Exeracer Pro<br>\$72.00<br>(Red Only) |                              |                               | <input type="checkbox"/> XM090 Tufo WS3 tubeless<br>\$72.00<br>(24" only and Blue only) |

### Spare Wheel

- |   |   |
|---|---|
| <input type="checkbox"/> EXAXK500 Spare wheel Spinerger<br>\$738.00<br>(All inclusive + axle pin) | <input type="checkbox"/> XK520 Spare wheel Titanium / Super narrow upcharge<br>\$118.00 |
|---|---|

### Inner Tube Valve Options

- |   |  |  |  |
|---|--|--|--|
| <input type="checkbox"/> XY500 Schraeder inner tube valve |  | <input type="checkbox"/> XY490 Presta inner tube valve<br>(Standard if no option selected) |  |
|---|--|--|--|

## FINISH OPTIONS

### Frame finish

 XN010 Powder coated frame

#### Frame Gloss

- Black gloss 103
- White gloss 100
- Grey gloss 132
- Cream gloss 135
- Red gloss 108
- Yellow gloss 120
- Forest green gloss 143
- Green gloss 107
- Dark blue gloss 151
- Royal blue gloss 154
- Blue gloss 174
- Duckegg blue gloss 141
- Pink gloss 188
- Orange gloss 180
- Purple gloss 157

#### Frame Matt

- Black matt 105
- White matt 101
- Grey matt 131
- Light grey matt 133
- Navy blue matt 152

#### Frame Special

- Chrome Mirror 300
- Sparkle silver 170
- Metallic black matt 104
- Metallic grey matt 130
- Black sandpaper 201
- Grey sandpaper 202
- White sandpaper 200

 XN200 Individual paint colour (State Colour/RAL code)  
\$150.00

 EXAXN030 Brushed frame  
\$304.00

 EXAXN050 Polished frame  
\$803.00

### Accent Colour

**Note:** Accent colour includes, forks, castor caps, and decals.

- |  |  |  |
|--|--|--|
| <input type="checkbox"/> Black accent  | <input type="checkbox"/> Silver accent                                 | <input type="checkbox"/> XN250 Individual accent<br>\$150.00 |
| <input type="checkbox"/> Red accent    | <input type="checkbox"/> Blue accent                                   | Select Colour:   |
| <input type="checkbox"/> Purple accent | <input type="checkbox"/> Carbon accent<br>(caps only, otherwise black) |  |

## UPHOLSTERY

### Seat Upholstery

 EXAXP040 Seat sling strap adjustable  
(Not required with seat plate)

### Backrest Upholstery

 EXAXP055 Airtech sport backrest strap adjustable

 XP070 Backrest upgrade to leather corners  
\$105.00 (Black)

### Backrest Stitching Options

- |                                 |                                |                                 |                                 |
|---------------------------------|--------------------------------|---------------------------------|---------------------------------|
| <input type="checkbox"/> Silver | <input type="checkbox"/> Black | <input type="checkbox"/> Blue   | <input type="checkbox"/> Orange |
| <input type="checkbox"/> Red    | <input type="checkbox"/>       | <input type="checkbox"/> Purple |                                 |

### Backrest RGK Logo Colour

- |                                      |                                     |                                 |                                      |
|--------------------------------------|-------------------------------------|---------------------------------|--------------------------------------|
| <input type="checkbox"/> White (Std) | <input type="checkbox"/> Green      | <input type="checkbox"/> Blue   | <input type="checkbox"/> Individual: |
| <input type="checkbox"/> Red         | <input type="checkbox"/> Light blue | <input type="checkbox"/> Purple | _____                                |

### Backrest Accessories

 XP170 Individual backrest embroidery  
\$119.00 (Please provide .jpeg file and positioning)

**CUSHION**

Cushion foam options



XP200 CX seat and backrest upholstery

Seat cushion foam thickness

7mm  10mm  25mm  50mm  Custom thickness

Seat cushion foam type

Soft  Med  Hard  Plastazote

Backrest foam thickness

7mm  10mm  25mm  50mm  Custom thickness

Backrest foam type

Soft  Med  Hard  Plastazote

Indicate Max Height:

580mm  630mm

**STRAPPING**

Velcro straps

- XS050 \$104.00 100mm Pro adjustable velcro strap
- XS055 \$104.00 50mm Pro adjustable velcro strap
- XS057 \$104.00 50mm Pro adjustable velcro **Knee** strap (measurement from tube to tube over knees)

Velcro strap position

Strap 1

Specify strap length

Specify distance from back post

Strap 1

Specify strap length

Specify distance from back post

Ratchet Straps

- XS020 \$71.00 Sport ratchet strap (Click strap)
- XS025 \$185.00 Pelvi Loc 2DA ratchet strap (For thighs and knees)
  - Select size:  Medium (8")  Large (10")
- XS030 \$198.00 Pelvi Loc 3DA ratchet strap (For hips)
  - Select size:  Small (8")  Medium (9")
  - Large (10")  Extra Large (11")
- XS035 \$118.00 M2 ratchet strap (For thighs and knees)
  - 8"  10"  12"

Ratchet strap position

Strap 1

Specify distance from back post

Strap 2

Specify distance from back post

- XS040 \$74.00 Fixed mounting points (one set per click strap)  x1  x2  x3

**FRAME OPTIONS**

- XR060 \$89.00 Calf strap mounting loops



- XR065 \$89.00 Strap location loops



**ACCESSORIES**

- XR030 \$87.00 Triple wheel bag (Black)
- XP130 \$79.00 Frame protectors full length
- XA150 \$56.00 Plastic tube fitted to offensive wing
- XS070 Foot strap (select if required)
- XS060 Calf strap (select if required)
- XP400 Back bar protector
- XR090 Tool kit

