

AI
ALUMINIUM 7020



CE

Customer Contact Details

Customer Name: _____

RGK Genius: _____

Address: _____

Phone: _____

Email: _____

Ship to Customer Address:

Shipping Name: _____

Shipping Address: _____

Phone: _____

Email: _____

Additional Information

Notes: _____

Current Wheelchair: _____

Customer Weight: _____

Customer Height: _____

Customer Disability: _____

Other

VAT Exemption Declaration (UK Only):
 I declare that I am chronically sick or disabled by reason of:

 and that I am receiving from RGK Wheelchairs Ltd, the wheelchair specified herein and I claim relief from Value Added Tax under group 12 of schedule 8 to Value Added Tax Act 1994.
 Signature: _____ Date: _____

RGK Contact Authorisation:
 From time to time, RGK would like to send you exclusive information, news and offers on everything RGK, by email or post. We will not pass any of your details to any third party.
 I would like to be contacted by RGK:
 Signature: _____ Date: _____

Guide:

- Base product
- Required option
- Optional Extra
- Critical Information
- Information Needed

PRODUCT STYLE

- PDAXZ011 PREDATOR**
\$7,123.00
- XA600 Heat treated frame
- XA240 Loose build fitting process
\$372.00

Max User Weight 125kg (275lbs)

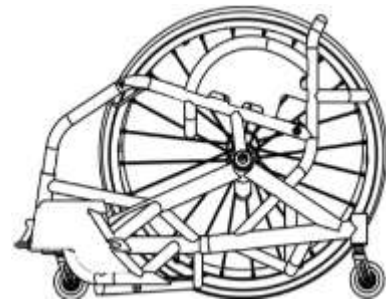

CAD APPROVAL

- XW010 CAD drawing for approval
\$169.00

KEY MEASUREMENTS

- XY010 Seat width (*Inside to inside of sideguards*)
 (Max - 500mm)
 (Min - 250mm)
- XY020 Seat length
 (Max - 500mm)
 (Min - 250mm)
- XY030 Extra seat length (*Provides additional leg support & hand grip*)
- XY050 Front frame height
- XY060 Rear frame height
 (Min - 280mm)
- XY070 Frame length
 (Min = XY020 + XY030 + 140mm)
- XA020 Ergonomic seat
 \$70.00
 Specify length
 (Standard = 120mm)

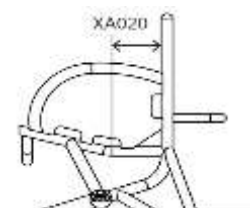
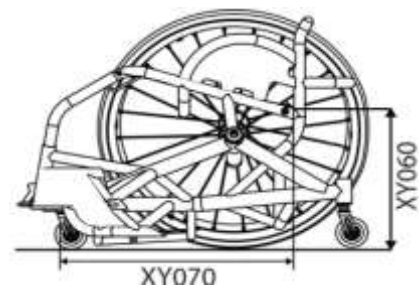
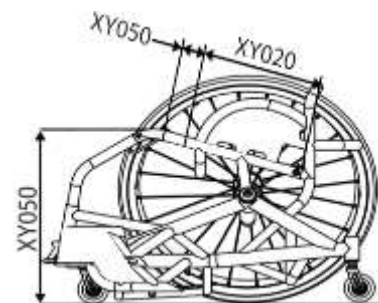
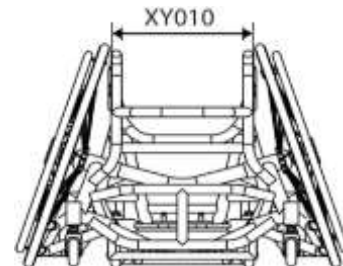

FRONT FRAME AND SEAT

Front Frame Options (Choose One)

XA061 Seat taper V-front design

Specify taper width
 mm

Specify front width
 mm (Std = 200mm)

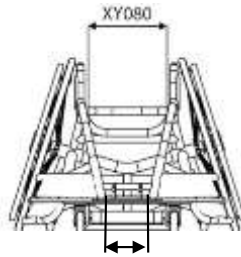

XA130 V-seat design
 \$185.00

Specify taper width
 mm

Specify front width
 mm (Std = 200mm)

FOOTREST

Fixed Footrest

PDAXB080 Fixed position footrest

Height and Position

Front footrest height

mm (min = 35mm)



Rear footrest height

mm (min = 35mm)



Footrest position
 (front of footplate to castor pot)

mm

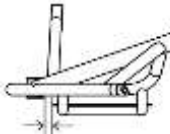

Footrest Size (Not ABS)

Footrest width

mm (Std= 200mm)

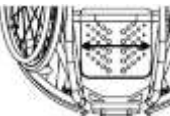

Footrest length

mm (Std = 250mm)

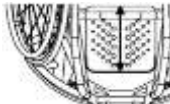

Footrest Plate

XB180 Aluminium footplate 2.5mm

XB100 ABS moulded foot tray
 \$113.00

Specify length
 mm (Max = 380mm (Full)
 Std = 330mm)

PDAXB140 Spacer kit
 \$16.00 (Allows for 25mm increase in height)

Adjustable Footrest

PDAXB130 Adjustable position footrest
 \$308.00 (Heavy duty)

Height and Position

Front footrest height

mm (min = 40mm)



Rear footrest height

mm (min = 40mm)



Footrest position
 (front of footplate to castor pot)

mm

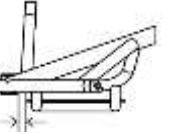

Footrest Size (Not ABS)

Footrest width

mm (Std= 200mm)



Footrest length

mm (Std = 250mm)



Footrest Plate

XB180 Aluminium footplate 5mm

XB100 ABS moulded foot tray
 \$113.00

Specify length
 mm (Max = 380mm (Full)
 Std = 330mm)

Footrest Plate Options

XB240 Aluminium raised edges
 \$66.00 (Cost per Edge)

Front Back Left Right

Specify height
 (Max = 60mm)

Castor Pin Width

XY330 Castor pin width

mm

Optimise measurements

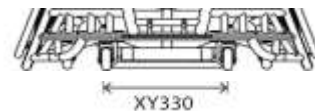

CAMBER BAR, WING AND ANTI-TIP

Fixed Centre of Gravity

PDAXY510 Fixed centre of gravity



(dimension taken from front of back rest to centre of axle)

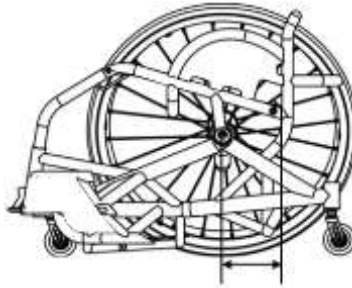

Specify Camber Angle

XY390 Camber angle

18
 (5/8" axle diameter only)

Wing Options (Choose one)

PDAXA126 **Defensive** rugby wing

PDAXA127 **Offensive** rugby wing
\$939.00 (select options below)

- Full upper wing
- Partial upper wing
- Full lower wing
- Partial lower wing

Wing details/drawings (use page 10 if req'd)

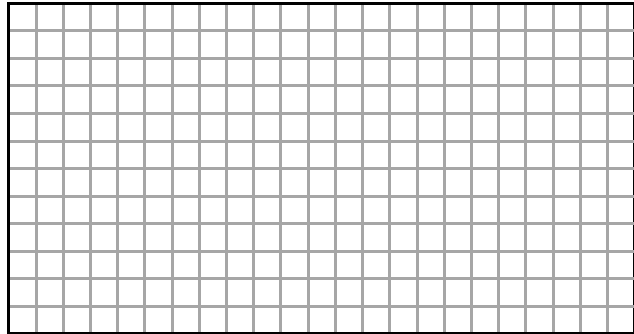

Picker Options (Choose one)

PDAXA400 **Defensive** rugby picker bolt on
\$766.00 (Draw requirements in opposite box)

PDAXA450 **Offensive** rugby picker fixed
\$229.00 (Draw requirements in opposite box)

Specify width (max 200mm)

mm

Specify depth

mm

Picker details/drawings (use page XX if req'd)

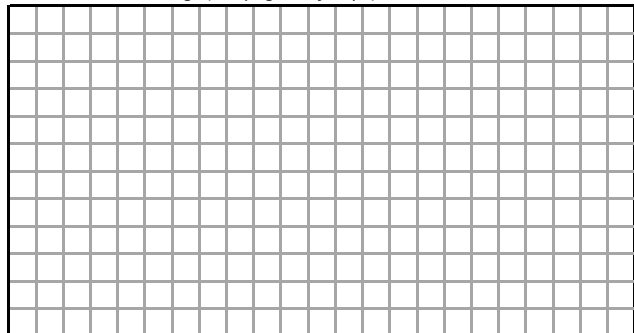

Anti-tip options

PDAXJ060 Anti tip double sport welded

XJ300 Anti tip low mount cross bar
\$72.00

PDAXJ200 Anti tip aluminium welded plate covers
\$320.00

PDAXJ210 Anti tip plastic plate covers
\$235.00

CASTOR AND REAR WHEELS

Castor Wheels & Forks

- | | |
|---|--|
| <input type="checkbox"/> XC160 Sport 61mm castor (Black) | <input type="checkbox"/> XC200 Sport micro fork (Black) |
| <input type="checkbox"/> XC170 Sport 72mm castor (Black) | <input type="checkbox"/> XC181 Castor wheel bearing Bones Reds |

REAR WHEELS

Rear Wheel Size

- XY420 24" Wheels XY430 25" Wheels

Wheel Gap (Choose one)

| | |
|---|--|
| <input type="checkbox"/> XY460 Rear wheel gap | <input type="checkbox"/> XY470 Inside to inside of wheel |
| <p>-10 -5 0 5 10 15</p> <p>Individual <input type="text"/> mm</p> | <p><input type="text"/> mm</p> |

Rear Wheel Options

- | | |
|---|---|
| <input type="checkbox"/> XK331 Spinergy SLX R10 heavy duty 24 spoke (Defensive & Offensive) | <input type="checkbox"/> PDAXK333 Spinergy XSLX R10 heavy duty 24 spoke \$64.00 (Offensive) |
|---|---|

Spinergy Colour Options

- | | | | |
|--|--|--|---|
| <input type="checkbox"/> Black spokes | <input type="checkbox"/> White spokes | <input type="checkbox"/> Yellow spokes | <input type="checkbox"/> XK180 Individual spoke design \$153.00 (Specify colour) |
| <input type="checkbox"/> Red spokes | <input type="checkbox"/> Blue spokes | <input type="checkbox"/> Pink spokes | Inside: _____ |
| <input type="checkbox"/> Purple spokes | <input type="checkbox"/> Orange spokes | <input type="checkbox"/> Green spokes | Outside: _____ |

Supply Without Wheels

- PDAXK040 Supply without Wheels
-\$569.00
- Wheel Type: Tyre Type:

Handrim Position / Options

- | | |
|---|--|
| <input type="checkbox"/> XL075 Narrow set handrim \$89.00 (10mm gap with tabs cut off) | <input type="checkbox"/> XL085 On rim handrim \$220.00 (No gap, tabs cut off) |
| <input type="checkbox"/> XL080 Super narrow set handrim \$177.00 (5mm gap with tabs cut off) | |

Handrim Style

- | | |
|---|--|
| <input type="checkbox"/> XL010 Aluminium hard anodised 6 tab | <input type="checkbox"/> XL200 Red Rubber Coated \$450.00 |
| <input type="checkbox"/> XL070 Aluminium hard anodised 12 tab \$89.00 (24" not available) | <input type="checkbox"/> XL050 Stainless steel 6 tab \$116.00 |

Handrim spokeguard Options

- | | |
|---|--|
| <input type="checkbox"/> XL500 Spokeguard poly dish offensive \$308.00 (riveted to hand rim) | <input type="checkbox"/> XL505 Spokeguard poly dish defensive \$245.00 (mounted to wheel rim) |
| | <input type="checkbox"/> XL515 Spokeguard poly dish raised defensive \$387.00 (Only with XL200 and XK331) |

Tyre Options

- | | |
|---|--|
| <input type="checkbox"/> XM010 Kenda <input type="checkbox"/> Grey <input type="checkbox"/> Red <input type="checkbox"/> Blue | <input type="checkbox"/> XM080 Tufo MS3 tubeless \$72.00 |
| <input type="checkbox"/> XM075 Kenda Kaliente <input type="checkbox"/> Red <input type="checkbox"/> Blue | <input type="checkbox"/> XM090 Tufo MS3 tubeless \$72.00 (24" only) |

Spare Wheel

- | | |
|---|--|
| <input type="checkbox"/> PDAXK500 Spare wheel Spinergy \$1,022.00 (All inclusive + axle pin) | <input type="checkbox"/> PDAXK510 Spare axle pin 5/8" \$47.00 |
|---|--|

Inner Tube Valve Options

- | | |
|---|--|
| <input type="checkbox"/> XY500 Schraeder inner tube valve | <input type="checkbox"/> XY490 Presta inner tube valve (Standard if no option selected) |
|---|--|

CUSHION

Cushion Options (choose one)

- XP080 Cushion foam (select density and size below) \$73.00
 - Soft (CMS040)
 - Medium (CMS050)
 - Hard (9lb recon)
 - Other
 - 50mm
 - 75mm
 - 100mm

Cushion Cover Upgrades

- XP085 Nylon cushion cover (Black)
- XP090 Air Lite cushion cover (Black) \$56.00

STRAPPING

Velcro straps

- XS050 100mm Pro adjustable velcro strap \$104.00
- XS055 50mm Pro adjustable velcro strap \$104.00
- XS057 50mm Pro adjustable velcro **Knee** strap (measurement from tube to tube over knees) \$104.00

Velcro strap position

Strap 1

Specify strap length

Specify distance from back post

Strap 1

Specify strap length

Specify distance from back post

Ratchet Straps

- XS020 Sport ratchet strap (Click strap) \$71.00
- XS025 Pelvi Loc 2DA ratchet strap (For thighs and knees) \$185.00
 - Select size: Medium (8") Large (10")
- XS030 Pelvi Loc 3DA ratchet strap (For hips) \$198.00
 - Select size: Small (8") Medium (9")
 - Large (10") Extra Large (11")
- XS035 M2 ratchet strap (For thighs and knees) \$118.00
 - 8" 10" 12"

Ratchet strap position

Strap 1

Specify distance from back post

Strap 2

Specify distance from back post

- XS040 Fixed mounting points (one set per click strap) \$74.00
 - x1
 - x2
 - x3

FRAME OPTIONS

- XR060 Calf strap mounting loops \$89.00
- XR065 Strap location loops \$89.00

BALL HOLDER

- XR300 Ball holder mounting points \$87.00
 - Specify distance from back post
 -
- XR310 Ball holder welded frame \$150.00 (please supply details on last page)
- XR320 Ball holder fabric \$104.00 (please supply details on last page)

ACCESSORIES

- XR030 Triple wheel bag (Black) \$87.00
- XS070 Foot strap (select if required)
- XP130 Frame protectors full length \$79.00
- XS060 Calf strap (select if required)
- XP400 Back bar protector
- XR090 Tool kit

