

AI
ALUMINIUM 7020



CE

Customer Contact Details

Customer Name: _____

Advisor: _____

Address: _____

Phone: _____

Email: _____

Ship to Customer Address:

Shipping Name: _____

Shipping Address: _____

Phone: _____

Email: _____

Additional Information

Notes: _____

Current Wheelchair: _____

Customer Weight: _____

Customer Height: _____

Customer Disability: _____

Other

VAT Exemption Declaration (UK Only):
 I declare that I am chronically sick or disabled by reason of:

 and that I am receiving from RGK Wheelchairs Ltd, the wheelchair specified herein and I claim relief from Value Added Tax under group 12 of schedule 8 to Value Added Tax Act 1994.
 Signature: _____ Date: _____

RGK Contact Authorisation:
 From time to time, RGK would like to send you exclusive information, news and offers on everything RGK, by email or post. We will not pass any of your details to any third party.
 I would like to be contacted by RGK:
 Signature: _____ Date: _____

Guide:

Base product

Required option

Optional Extra



Critical Information



Information Needed

PRODUCT STYLE

AGAXZ011 ALLSTAR G2
\$3,473.00

AGAXA088 Basketball (with wing)

AGAXA089 Tennis (no wing)

AGAXA147 Rugby Upgrade
\$382.00

Max User Weight 115kg (253lbs)

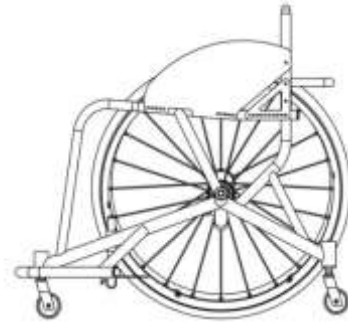

CAD APPROVAL

XW010 CAD drawing for approval
\$169.00

KEY MEASUREMENTS

XY010 Seat width (*Inside of sideguards*)

 mm

(Max - 500mm)
(Min - 250mm)

XY020 Seat length

 mm

(Max - 500mm)
(Min - 250mm)

XY030 Extra seat length (*Provides additional leg support & hand grip*)

 mm

XY050 Front frame height

 mm

(Max - 630mm)
(Min - 360mm)

XY060 Rear frame height

 mm

(Max - 630mm)
(Min - 360mm)

XY070 Frame length

 mm

(Min XY020 + XY030 + 110mm)

XA020 Ergonomic seat
\$70.00



Specify length
 mm

(Standard = 120mm)

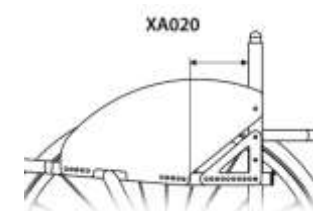
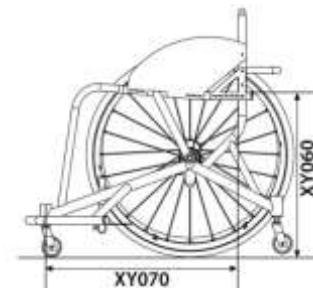
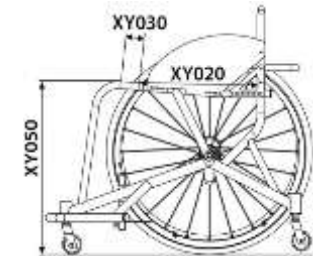
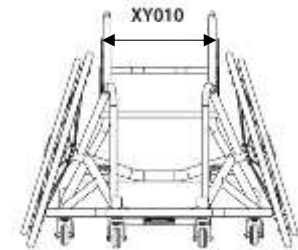

FRONT FRAME AND SEAT

Front Frame Options

- XY085 Seat taper design
\$70.00

i Specify width mm

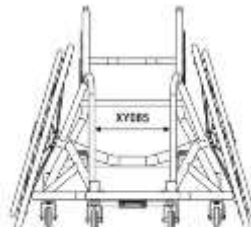

- AGAXA200 Knee support System (For Tennis)
\$381.00

Specify length mm

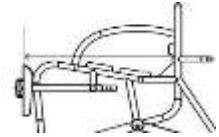

- Optimise (Smallest)

Seat Options

- XR040 Aluminium seat plate (Riveted to frame)
\$116.00

i mm
(Std XY020 - 20mm)

- XR050 Carbon fibre seat plate (Riveted to frame)
\$295.00

i mm
(Std XY020 - 20mm)

FOOTREST

Fixed Footrest

- AGAXB080 Fixed position footrest
\$193.00

Height and Position

- Front footrest height
 mm (min = 35mm)
- Rear footrest height
 mm (min = 35mm)
- Footrest position (front of footplate to castor pot)
 mm

Footrest Size

- Footrest width
 mm (Std = 200mm)
- Footrest length
 mm (Std = 250mm)

Footrest Plate

- XB180 Aluminium footplate (2.5mm)
- XB190 Carbon fibre footplate
\$192.00
- XB100 ABS moulded foot tray
\$113.00

Specify length mm
Max = 380mm (Full)
Std = 330mm

Adjustable Footrest

- AGAXB130 Clamp on adjustable position footrest (100mm range)
- AGAXB085 Adjustable position footrest (50mm range)

Height and Position

- Front footrest height
 mm (min = 40mm)
- Rear footrest height
 mm (min = 40mm)
- Footrest position (front of footplate to castor pot)
 mm

Footrest Size

- Footrest width
 mm (Std = 200mm)
- Footrest length
 mm (Std = 250mm)

Footrest Plate

- XB180 Aluminium footplate (5mm)
- XB100 ABS moulded foot tray
\$113.00

Specify length mm
Max = 380mm (Full)
Std = 330mm

Castor Pin Width

- XY330 Castor pin width

i mm

- Optimise measurements



CAMBER BAR, WING AND ANTI-TIP

Centre of Gravity

AGAXY510 Fixed centre of gravity



Specify measurement
 mm

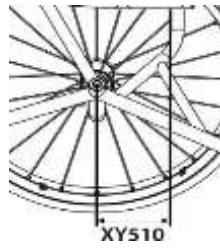

AGAXY515 Backrest COG adjustment
 (+/- 20mm)
 (Not with welded sides)

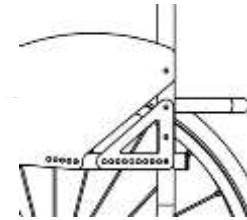

Specify Camber Angle

XY390 Camber angle



16 18 20 22

Wing Options

AGAXA110 Round design basketball wing

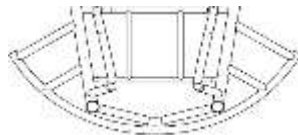

AGAXA140 No Wing (Tennis)



AGAXA120 Straight sided design basketball wing
 \$154.00

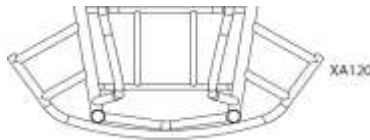

AGAXA125 Arrow design basketball wing
 \$154.00

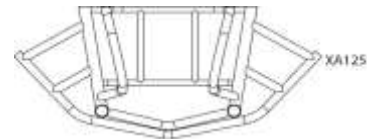

Anti-tip options

AGAXJ040 Single fixed anti tip

Specify position

- Basketball (5mm inside rear wheel)
- Tennis (100mm outside rear wheel)

AGAXJ060 Double fixed anti tip
 \$193.00 (for Basketball)

Specify width



mm

Optimise measurements
 (Wide as possible - std if not indicated)

SIDEGUARDS

Sideguard Style

XE030 Screw on aluminium
\$154.00

XE050 Screw on carbon fibre
\$343.00

AGAXE230 Welded sport
\$328.00 (Not with backrest COG Adj - AGAXY510)

XE310 High design upgrade
\$154.00 (only with AGAXE230)



Sideguard Measurements

Sideguard length
 mm

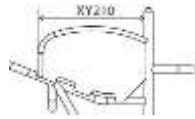

Sideguard height
 mm

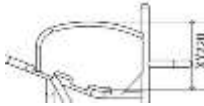

Sideguard height (front)
 mm



Follow Tyre Design

25mm above tyre

Individual above tyre
 mm

Level with tyre



BACKREST

Backrest Height

XY230 Fixed height backrest
 Specify height
 mm

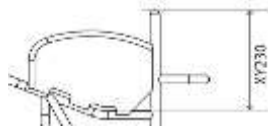

AGAXY245 Adjustable height backrest (+/- 25mm)
Specify height
 mm

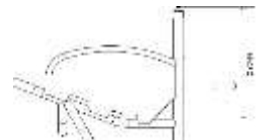

Ergonomic Options

XY360 Backrest angle
-5 -3 0 +3 +5

Individual Deg
(Max -10/+10 Deg)

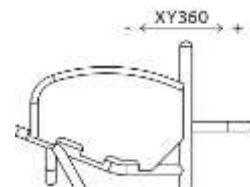

XG100 Ergonomic backrest (not with AGAXY245)
Vertical height mm
Rearward position mm

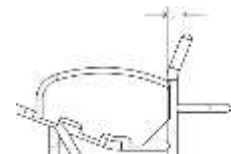
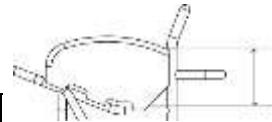

XG110 Inward taper (not with AGAXY245)
Specify width or per side
 mm

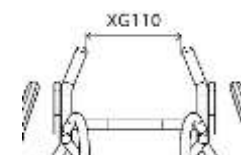

XG120 Outward flare (not with AGAXY245)
Specify width or per side
 mm

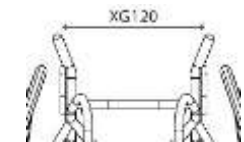

CASTORS AND REAR WHEELS

Castor Options

- | | |
|--|--|
| <input checked="" type="checkbox"/> XC160 Sport 61mm castor
(Black) | <input type="checkbox"/> XC180 Bones Reds bearings
\$83.00 |
| <input type="checkbox"/> AGAXC230 Extruded aluminium castor fork | <input type="checkbox"/> AGAXC200 Sport micro fork
\$105.00 |

Rear Wheel Size

- | | | | |
|---|---|---|--|
| <input type="checkbox"/> XY420 24" Wheels | <input type="checkbox"/> XY430 25" Wheels | <input type="checkbox"/> XY440 26" Wheels | <input type="checkbox"/> XY450 700C Wheels |
|---|---|---|--|

Rear Wheel Gap

- XY460 Rear wheel gap
-
- 15 20 25
- Individual mm

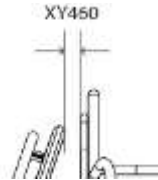

Rear Wheel Options

- | | | |
|---|---|--|
| <input type="checkbox"/> XK030 Equalizer 36/48 spoke
(Black hub, black spokes) | <input type="checkbox"/> XK100 Spinergy XSLX 24 spoke
\$690.00 (Tennis) | <input type="checkbox"/> XK330 Spinergy R10 SLX 24 spoke
\$1,211.00 |
| <input type="checkbox"/> XK080 Spinergy SLX 24 spoke
\$655.00 | <input type="checkbox"/> XK101 Spinergy XSLX 24 spoke + caps
\$719.00 (Basketball) | |

Spinergy Colour Options:

- | | | | |
|--|--|--|--|
| <input type="checkbox"/> Black spokes | <input type="checkbox"/> White spokes | <input type="checkbox"/> Yellow spokes | <input type="checkbox"/> XK180 Individual spoke design
\$153.00 |
| <input type="checkbox"/> Red spokes | <input type="checkbox"/> Blue spokes | <input type="checkbox"/> Pink spokes | |
| <input type="checkbox"/> Purple spokes | <input type="checkbox"/> Orange spokes | <input type="checkbox"/> Green spokes | Inside: _____ |
| | | | Outside: _____ |

Spinergy Anodise Options

- | | | | |
|--|--|--|---|
| <input type="checkbox"/> XK190 Black hub
(std option) | <input type="checkbox"/> XK200 Silver hub
\$80.00 | <input type="checkbox"/> XK201 Red hub/rims
\$162.00 | <input type="checkbox"/> XK205 Individual hub/rims
\$213.00 Select colour: _____ |
| <input type="checkbox"/> XK202 Purple hub/rims
\$162.00 | <input type="checkbox"/> XK203 Blue hub/rims
\$162.00 | <input type="checkbox"/> XK204 Gold hub/rims
\$213.00 | |

Supply Without Wheels

- | | | |
|---|----------------------------------|---------------------------------|
| <input type="checkbox"/> XK040 Supply without Wheels
-\$161.00 | Wheel Type: <input type="text"/> | Tyre Type: <input type="text"/> |
|---|----------------------------------|---------------------------------|

Handrim Position / Options

- | | |
|--|--|
| <input type="checkbox"/> XY480 Narrow set handrim | <input type="checkbox"/> XY485 Wide set handrim |
| <input type="checkbox"/> XL090 Remove excess mounting tabs
\$89.00 (recommended for small wheel gaps) | <input type="checkbox"/> XL080 Super narrow set handrim
\$177.00 (only with XL040 and includes XL090) |

Handrim Styles

- | | |
|--|---|
| <input type="checkbox"/> XL010 Aluminium hard anodised 6 tab | <input type="checkbox"/> XL040 Titanium 6 tab
\$210.00 (Not with 700C) |
| <input type="checkbox"/> XL070 Aluminium hard anodised 12 tab
\$89.00 (24" not available) | <input type="checkbox"/> XL050 Stainless steel 6 tab
\$116.00 |

Tyre Options

- | | | | | |
|---|-------------------------------|-------------------------------|--|--|
| <input type="checkbox"/> XM010 Kenda | <input type="checkbox"/> Grey | <input type="checkbox"/> Blue | <input type="checkbox"/> Red | |
| <input type="checkbox"/> XM075 Kenda Kaliente
\$29.00 | <input type="checkbox"/> Red | <input type="checkbox"/> Blue | <input type="checkbox"/> XM080 Tufo MS3 tubeless
\$72.00 (Blue only) | |
| <input type="checkbox"/> XM150 IRC Exeracer Pro
\$72.00 (Red only) | | | <input type="checkbox"/> XM090 Tufo WS3 tubeless
\$72.00 (24" only and Blue only) | |

Spare Wheel

- | | |
|---|--|
| <input type="checkbox"/> AGAXK500 Spare wheel Spinergy
\$738.00 (All inclusive + axle pin) | <input type="checkbox"/> XK520 Spare wheel upcharge
\$118.00 (for Titanium or super narrow push rims) |
|---|--|

Inner Tube Valve Options

- | | | | |
|---|--|--|--|
| <input type="checkbox"/> XY500 Schraeder inner tube valve | | <input type="checkbox"/> XY490 Presta inner tube valve
(Standard if no option selected) | |
|---|--|--|--|

FRAME FINISH OPTIONS

Frame & Component Finish

XN010 Powder coated frame XN150 Powder coated components (Frame colour if not specified)

Frame Comp. Gloss Frame Comp. Matt Frame Comp. Special

- | | | |
|--|---|---|
| <input type="checkbox"/> <input type="checkbox"/> Black gloss 103 | <input type="checkbox"/> <input type="checkbox"/> Black matt 105 | <input type="checkbox"/> <input type="checkbox"/> Chrome Mirror 300 |
| <input type="checkbox"/> <input type="checkbox"/> White gloss 100 | <input type="checkbox"/> <input type="checkbox"/> White matt 101 | <input type="checkbox"/> <input type="checkbox"/> Sparkle silver 170 |
| <input type="checkbox"/> <input type="checkbox"/> Grey gloss 132 | <input type="checkbox"/> <input type="checkbox"/> Grey matt 131 | <input type="checkbox"/> <input type="checkbox"/> Metallic black matt 104 |
| <input type="checkbox"/> <input type="checkbox"/> Cream gloss 135 | <input type="checkbox"/> <input type="checkbox"/> Light grey matt 133 | <input type="checkbox"/> <input type="checkbox"/> Metallic grey matt 130 |
| <input type="checkbox"/> <input type="checkbox"/> Red gloss 108 | <input type="checkbox"/> <input type="checkbox"/> Navy blue matt 152 | <input type="checkbox"/> <input type="checkbox"/> Black sandpaper 201 |
| <input type="checkbox"/> <input type="checkbox"/> Yellow gloss 120 | | <input type="checkbox"/> <input type="checkbox"/> Grey sandpaper 202 |
| <input type="checkbox"/> <input type="checkbox"/> Forest green gloss 143 | | <input type="checkbox"/> <input type="checkbox"/> White sandpaper 200 |
| <input type="checkbox"/> <input type="checkbox"/> Green gloss 107 | | |
| <input type="checkbox"/> <input type="checkbox"/> Dark blue gloss 151 | | |
| <input type="checkbox"/> <input type="checkbox"/> Royal blue gloss 154 | | |
| <input type="checkbox"/> <input type="checkbox"/> Blue gloss 174 | | |
| <input type="checkbox"/> <input type="checkbox"/> Duckegg blue gloss 141 | | |
| <input type="checkbox"/> <input type="checkbox"/> Pink gloss 188 | | |
| <input type="checkbox"/> <input type="checkbox"/> Orange gloss 180 | | |
| <input type="checkbox"/> <input type="checkbox"/> Purple gloss 157 | | |

XN200 Individual paint colour (State Colour/RAL code) \$150.00

Frame Comp

AGAXN030 Brushed frame finish \$304.00 XN160 Brushed components \$115.00

Accent Colour

Note: Accent colour includes, forks, castor caps, decals.

- | | | |
|--|--|--|
| <input type="checkbox"/> Black accent | <input type="checkbox"/> Silver accent | <input type="checkbox"/> XN250 Individual accent \$150.00 |
| <input type="checkbox"/> Red accent | <input type="checkbox"/> Blue accent | <input style="border: 1px solid black; width: 100px; height: 20px;" type="text" value="Select Colour:"/> |
| <input type="checkbox"/> Purple accent | | |

UPHOLSTERY

Seat Upholstery / Plate

XP040 Seat sling strap adjustable (Not required with seat plate)

Backrest Upholstery

- | | |
|--|---|
| <input type="checkbox"/> XP030 Nylon backrest strap adjustable (Black) | <input type="checkbox"/> XP070 Backrest upgrade to leather corners (Black) \$105.00 |
| <input type="checkbox"/> AGAXP055 Airtech sport backrest strap adjustable (Black) \$166.00 | |

Backrest Stitching Options

- | | | | |
|---------------------------------|-------------------------------------|---------------------------------|---------------------------------|
| <input type="checkbox"/> Silver | <input type="checkbox"/> Black | <input type="checkbox"/> Blue | <input type="checkbox"/> Orange |
| <input type="checkbox"/> Red | <input type="checkbox"/> Light blue | <input type="checkbox"/> Purple | |

Backrest RGK Logo Colour

- | | | | |
|--------------------------------------|-------------------------------------|---------------------------------|--------------------------------------|
| <input type="checkbox"/> White (Std) | <input type="checkbox"/> Green | <input type="checkbox"/> Blue | <input type="checkbox"/> Individual: |
| <input type="checkbox"/> Red | <input type="checkbox"/> Light blue | <input type="checkbox"/> Purple | |

Backrest Accessories

XP170 Individual backrest embroidery \$119.00 (Please provide .jpeg file and positioning)

CUSHION

Cushion Foam Options

- XP080 \$73.00 Cushion foam (select density and size below)
 - Soft (CMS040)
 - Medium (CMS050)
 - Hard (9lb recon)
 - 50mm
 - 75mm
 - 100mm
 - Other
- XP340 \$68.00 Plastazote cushion upgrade (Indicate max height for Basketball)
 - 580mm
 - 630mm

Cushion Cover Options

- XP085 Nylon cushion cover (Black)
- XP090 Air Lite cushion cover (Black)
- XP380 Neoprene cushion cover (Black)

STRAPS

Velcro straps

- XS010 \$40.00 100mm adjustable velcro strap
- XS050 \$104.00 100mm Pro adjustable velcro strap
- XS057 \$104.00 50mm Pro knee strap (measurement from tube to tube over knees)

Velcro strap position

Strap 1

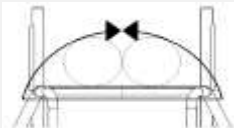

Specify strap length

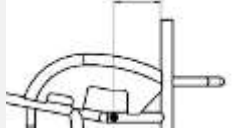

Specify distance from back post

Strap 1

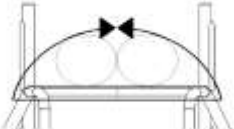

Specify strap length

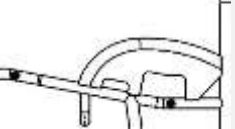

Specify distance from back post

Ratchet Straps

- XS020 \$71.00 Sport ratchet strap (Click strap) (11" x 2" pad)
- XS025 \$185.00 Pelvi Loc 2DA ratchet strap (For thighs and knees)
 - Select size: Medium (8.5") Large (10")
- XS030 \$198.00 Pelvi Loc 3DA ratchet strap (For hips)
 - Select size: Small (8") Medium (9")
 - Large (10") Extra Large (11")
- XS035 \$118.00 M2 ratchet strap (For thighs and knees)
 - Select size: 8" 10" 12"

Ratchet strap position

Strap 1



Specify distance from back post

Strap 2

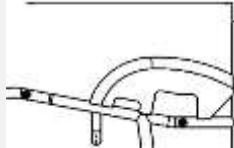

Specify distance from back post

- XS040 \$74.00 Fixed mounting points (one set per click strap)
 - x1
 - x2
 - x3
- XS045 \$74.00 Clamped mounting points (one set per click strap)
 - x1
 - x2
 - x3

FRAME OPTIONS

- XR060 \$89.00 Calf strap mounting loops
 
- XR065 \$66.00 Strap location loops
 

ACCESSORIES

- XR030 \$87.00 Triple wheel bag (Black)
- XS070 Foot strap (select if required)
- XP130 \$79.00 Frame protectors full length
- XS060 Calf strap (select if required)
- XA150 \$56.00 Plastic tube fitted to offensive wing
- XP400 Back bar protector
- XR090 Tool kit

NOTES

Large empty rectangular area for notes.

Large grid area for notes.