

Date

User name

Company stamp

Responsible

Carbon fibre frame made-to-measure.

NOIR is a wheelchair without possibilities of adjustments after its manufacturing..

See reference tables

Take care to write all the requested measures (in centimetres)

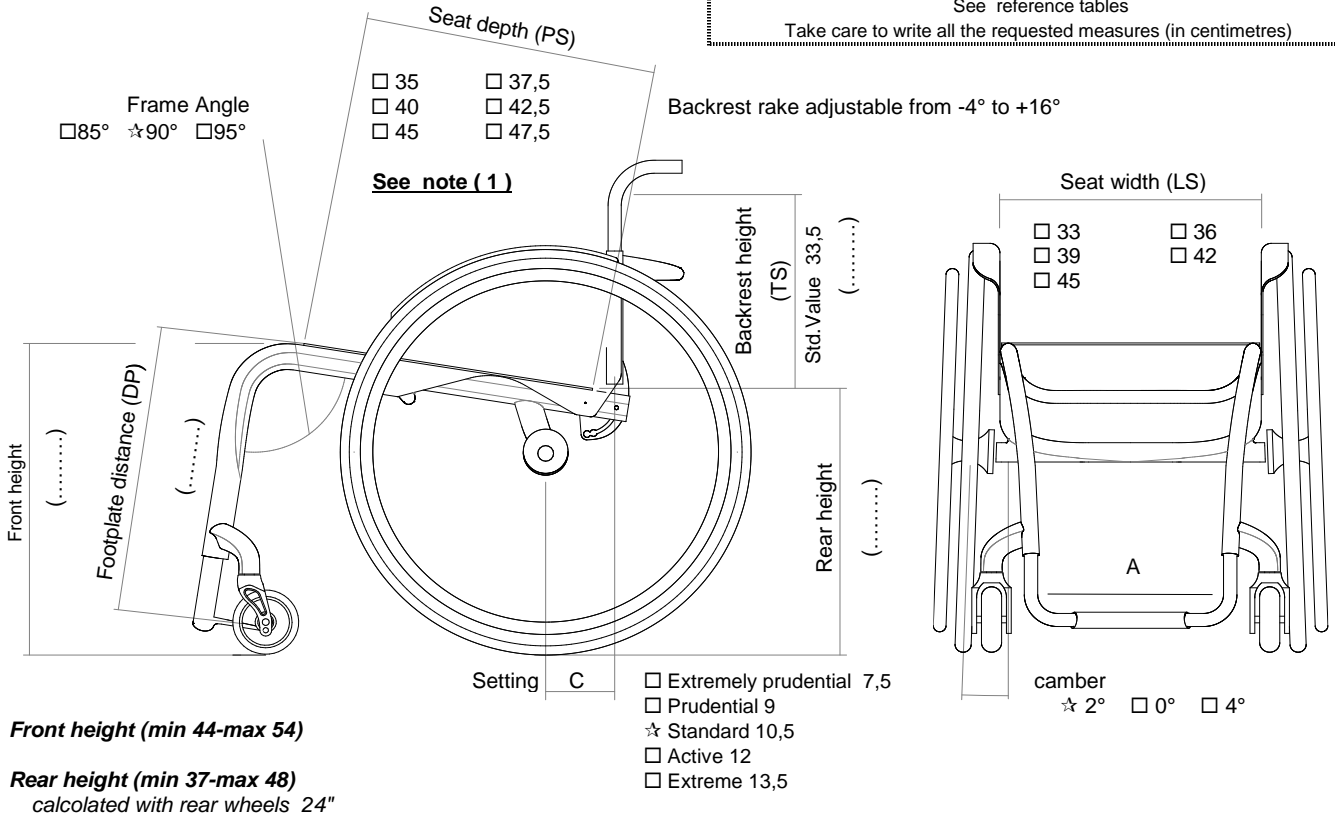

Footplate option

- Carbon fibre frame with integrated footplate, not adjustable
(Lightest configuration)
- Aluminium footplate adjustable distance +/- 1,5cm (rake and depth adjustable)
Minimum footplate distance 35cm.
 Internal 2/3 Internal 2/3 External External

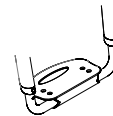

ESSENCE

Essence - Glossy
Polished transparent painting

Essence - Opaque
Opaque transparent painting

<input checked="" type="checkbox"/> CARBON Essence			<input type="checkbox"/> OPAQUE Essence	08925	500,00
<input type="checkbox"/> LIME Essence	08926	700,00	<input type="checkbox"/> LIME Opaque Essence	10352	900,00
<input type="checkbox"/> RED Essence	08927	700,00	<input type="checkbox"/> RED Opaque Essence	10353	900,00
<input type="checkbox"/> BLUE Essence	08928	700,00	<input type="checkbox"/> BLUE Opaque Essence	10354	900,00
<input type="checkbox"/> ORANGE Essence	10349	700,00	<input type="checkbox"/> ORANGE Opaque Essence	10355	900,00
<input type="checkbox"/> WHITE Essence	10350	700,00	<input type="checkbox"/> WHITE Opaque Essence	10356	900,00
<input type="checkbox"/> ANTHRACITE Essence	10351	700,00	<input type="checkbox"/> ANTHRACITE Opaque Essence	08929	900,00

MY ESSENCE COLOUR RAL _____ Glossy Opaque

Note _____ Price to estimate

Since that the paint is sensitive to the surface material and texture, the colour selected for the wheelchair frame can also differ considerably from what is displayed on a RAL colour chart or also compared to what is displayed on a monitor.

Fork colour

- Opaque black
- Pearl white

Date Order English User name Address

Seat

☆ Seat cloth with pocket (under seat)

○ Seat with tension straps 08883 **180,00**

○ Carbon rigid seat 08336 **380,00**

○ Pocket (under seat) [25x11x4,5] 08281 **60,00**

Backrest adjustment and fixing system

☆ Backrest with double locking (upright and folded) with rake adjustable from -4° to +16°

Backrest with upright locking system ONLY (no locking when folded) with rake adjustable from -4° to +16°

Fixed back(non-folding back) with rake adjustable from -4° to +16°

○ Integrated backrest (Banded, not folding back) 10841 **1.000,00**
 Exclude installation of the titanium backrest

(.....) to the ground (.....) to the ground

Backrest

☆ Adjustable velcro straps and padded transpiring upholstery ☆ Carbon fibre backrest

Titanium backrest Not available with: Integrated backrest (Banded, not folding back)

○ **AIR** Integrated posture backrest (NOT REMOVABLE) **840,00**

Carbon shell - Lateral retaining 7,5cm
 Depth adjustment ±1cm. - Angle adjustment ±10°
 not available for seat width 48

H 28		H 34		H 40	
Backrest Height (TS) min 34 (.....)		Backrest Height (TS) min 38 (.....)		Backrest Height (TS) min 44 (.....)	
Lateral retaining wing A=high - R=regular					
A	R	A	R	A	R
<input type="checkbox"/>	<input type="checkbox"/>	<input type="checkbox"/>	<input type="checkbox"/>	<input type="checkbox"/>	<input type="checkbox"/>

Installation on:

☆ Aluminium backrest tubes
 (Carbon tubes with integrated backrest)

Carbon fibre backrest

Titanium backrest
 Not available with: Integrated backrest (Banded, not folding back)

Handle tube

☆ Handle tube with short tubes (Lightest configuration)

Handle tube SPORT Without push handles

○ Folding handles aluminium 02958 **200,00**

Casters

☆ 3" Sport (Lightest configuration)

4" Soft

3" Active Soft (wide) (Aluminium alloy rim)

4" Active Sport (narrow) (Aluminium alloy rim)

4" Active Soft (wide) (Aluminium alloy rim)

5" Active Soft (wide) (Aluminium alloy rim)

5" Pneumatic

Rear wheels - See chart N°3

☆ 24" ULTRA-LIGHT PROGEO KEY SPORT (Lightest configuration)

24" Ultra-light "Spinergy LX"

24" Ultra-light "Spinergy LXL" Black hub and white spokes Hub and spokes black

25" Ultra-light "Spinergy LX" Black hub and white spokes

25" Ultra-light "Spinergy LXL"

26" Ultra-light "Spinergy LX"

Rehateam s.r.l. Vicolo Negrelli, 5 - 31040 Castagnole di Paese (TV) - Tel. +39.0422.484657 / +39.0422.480387 - Fax +39.0422.484661 / +39.0422.484684
 P.IVA IT 03182520286 - C.C.I.A.A. TV n. 225867 - Iscr. Trib. TV n. 41690 Capitale Sociale I.V. Euro 100.000,00







Email: info@rehateamprogeo.com - web: http://www.rehateamprogeo.com

English

<u>Date</u>	<u>Order</u>	<u>User name</u>	<u>Address</u>
-------------	--------------	------------------	----------------

Rear wheel tyre			
<input checked="" type="checkbox"/> High pressure tyre	(24"-25"-26")	(Lightest configuration)	
<input type="checkbox"/> High pressure profile tyre	(24")		
<input type="checkbox"/> Marathon Plus	(24"-25")	with anti-puncture protection	01669 50,00
<input type="checkbox"/> Solid tyre Kik Mako - Colour Black	(24")		01041 100,00
<input type="checkbox"/> Solid tyre Kik Mako - Colour Grey	(24")		01751 100,00

Handrim - Wheel distance		<input checked="" type="checkbox"/> 3 cm	<input type="checkbox"/> 4 cm	
<input checked="" type="checkbox"/> Aluminium	(24"-25"-26")	(Lightest configuration)		
<input type="checkbox"/> Aluminium black SOFT-TOUCH	(24"-25")	(24" handrim, on 25" wheel is installed with spacers)	09170	100,00
<input type="checkbox"/> Chromed Steel	(24"-25")	(24" handrim, on 25" wheel is installed with spacers)	01684	120,00
<input type="checkbox"/> Titanium	(24"-25")	(24" handrim, on 25" wheel is installed with spacers)	00016	220,00
<input type="checkbox"/> Ultra Grepp	(24"-25")	(24" handrim, on 25" wheel is installed with spacers)	00017	250,00
<input type="checkbox"/> Max Grepp	(24"-25")	(24" handrim, on 25" wheel is installed with spacers)	00834	280,00
<input type="checkbox"/> Ergo Para	(24")		00632	280,00
<input type="checkbox"/> SURGE LT	(24"-25")	Oval countour with a rubber insert	06427	290,00
<input type="checkbox"/> Quad (24")	(24")		00693	160,00
<input type="checkbox"/> Silicon cover for standard aluminium handrim		Available for measures (22" - 24" - 26")	04050	130,00

Wheel locks			
<input checked="" type="checkbox"/> Without brake			
<input type="checkbox"/> Bent lever push to lock			
<input type="checkbox"/> Straight lever Push to lock			
<input type="checkbox"/> Straight lever Pull to lock			
<input type="checkbox"/> Sport brake		(Lightest configuration)	
<input type="checkbox"/> Brake with extension lever push to lock			
<input type="checkbox"/> Brake with extension lever pull to lock			

Mudguard			
<input checked="" type="checkbox"/> Carbon fibre mudguard			
<input type="checkbox"/> Carbon fibre Straight sideguard	<input checked="" type="checkbox"/> Aligned wheel	<input type="checkbox"/> Under wheel cm	<input type="checkbox"/> Above wheel cm
<input type="checkbox"/> Removable carbon fibre mudguard			04109 200,00
<input type="checkbox"/> Removable Carbon fibre straight sideguard	<input checked="" type="checkbox"/> Aligned wheel	<input type="checkbox"/> Under wheel cm	<input type="checkbox"/> Above wheel cm
			04109 200,00

Armrests			
<input type="checkbox"/> Swing away armrests	(Swing away, removable and height adjustable armrest)		00694 200,00
	<input checked="" type="checkbox"/> Pad STANDARD		
	<input type="checkbox"/> Ergonomic pad (30x6 cm.)		04104 50,00

Accessories			
<input type="checkbox"/> Pad for front frame protectors			07058 40,00
<input type="checkbox"/> Backrest-seat connection cloth			10241 15,00
<input type="checkbox"/> Removable storage bag (with quick coupling)			09811 100,00

Optional 1			
<input type="checkbox"/> Transit wheels			 03290 120,00
<input type="checkbox"/> Anti-tipper with rapid hookup	(inside rotation to reduce the encumbrance)		
	<input type="checkbox"/> Right		06821 100,00
	<input type="checkbox"/> Left		06822 100,00
<input type="checkbox"/> Lumbar support	(to insert in the backrest upholstery)		00013 30,00
<input type="checkbox"/> Tetraclip	(Quick release axle for quadriplegic)		03947 140,00

Additional Kit			
<input type="checkbox"/> 24" Off-road rear wheels	Off-Road tyre - aluminium handrim (black colour)		03378 400,00
<input type="checkbox"/> 24" FAT rear wheels	FAT tyre 3" - aluminium handrim (black colour)		09357 700,00

Rehateam s.r.l. Vicolo Negrelli, 5 - 31040 Castagnole di Paese (TV) - Tel. +39.0422.484657 / +39.0422.480387 - Fax +39.0422.484661 / +39.0422.484684
 P. IVA IT 03182520266 - C.C.I.A.A. TV n. 225867 - Iscr. Trib. TV n. 41690 Capitale Sociale I. V. Euro 100.000,00





Email: info@rehateamprogeo.com - web: http://www.rehateamprogeo.com

Date Order English User name Address



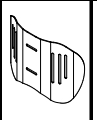
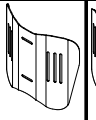
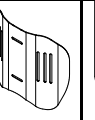
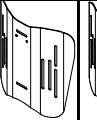

PHYSIO - Posture backrest - Std. Backrest upholstery not provided

Removable with quick release
Suitable for tubes with diameter 18÷26mm
Depth adjustment (4cm)
Angle adjustment (±18°)

AIR Carbon shell
not available for seat width 48

BACKREST HEIGHT	28	34	40	840,00		
Shell's shape 	Lateral retaining wing A=high - R=regular					
	A	R	A		R	A
						
	<input type="checkbox"/>	<input type="checkbox"/>	<input type="checkbox"/>	<input type="checkbox"/>	<input type="checkbox"/>	<input type="checkbox"/>

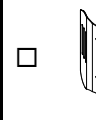
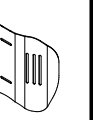
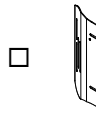
POSTURE Aluminum shell

BACKREST HEIGHT	34	40	52	810,00	
Shell's shape 	Lateral retaining wing B=regular				
	R	R	R		R
					
	<input type="checkbox"/>	<input type="checkbox"/>	<input type="checkbox"/>	<input type="checkbox"/>	

Configuration DEEP with side support PAD (height adjustable)

Aluminum lateral with padded, breathable upholstery.



Small (h 13cm)



Right 10272

25,00

Left 10272

25,00

Large (h 20cm)



Right 10273

30,00

Left 10273

30,00

SWING AWAY - Lateral support

Fixing and adjustment hardware complete with protection sleeve
Aluminum lateral with padded, breathable upholstery.

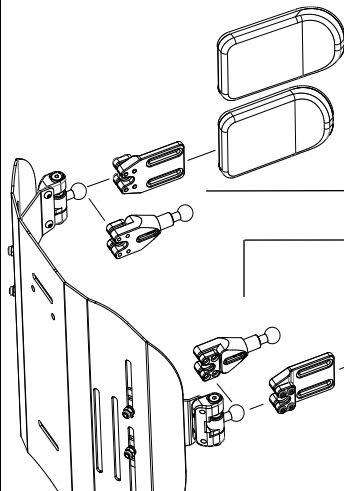

Large (18x12)

05647 **150,00**

Small (14x9)

05643 **150,00**

Lateral support extension

Quantity (number pcs).....

10271 **55,00**

Lateral support extension

Quantity (number pcs).....

Small (14x9)

05642 **150,00**

Large (18x12)

05646 **150,00**

Headrest adjustable - Double ball mounting system

Available only with backrest Physio
Not available for backrest Physio AIR carbon shell



Large (34x14)

05648 **200,00**

Small (28x14)

Rehateam s.r.l. Vicolo Negrelli, 5 - 31040 Castagnole di Paese (TV) - Tel. +39.0422.484657 / +39.0422.480367 - Fax +39.0422.484661 / +39.0422.484684
P.IVA IT 03182520266 - C.C.I.A.A. TV n. 225667 - Iscr. Trib. TV n. 41690 Capitale Sociale I.V. Euro 100.000,00

Email: info@rehateamprogeo.com - web: http://www.rehateamprogeo.com

English

Date Order User name Address

REFERENCE TABLES

IMPORTANT NOTICE NOIR is a wheelchair without possibilities of adjustments after its manufacturing.
 (1) The real seat depth, from the front part of the seat cloth to the backrest tube will be 1,5 cm more than the declared one.

1	A Footplate width			
	DP	35÷39	40÷45	46÷50
LS				
33	21,5	21	20,5	
36	24,5	24	23,5	
39	27,5	27	26,5	
42	30,5	30	29,5	
45	33,5	33	32,5	
48	36,5	36	35,5	

2	Setting	C :
	Extremely prudential	7,5
	Prudential	9
	Standard	10,5
	Active	12
	Extreme	13,5

3	Maximum width
Camber	
0°	LS + 18
2°	LS + 21
4°	LS + 24

Maximum width calculated including 3 cm. distance between tyre and handrim