

Powered Wheelchair



Quickie F35 R2

Instructions for Use

**QUICKIE**[®]

P19153

www.sunrisemedical.com

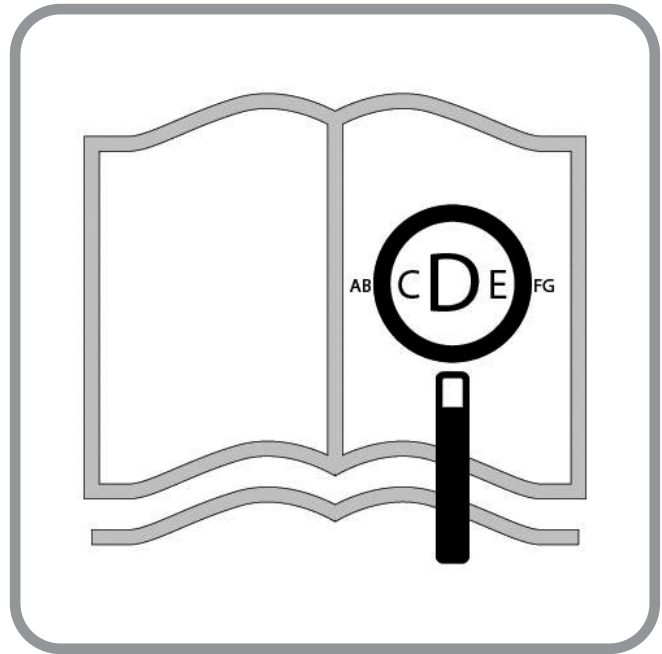
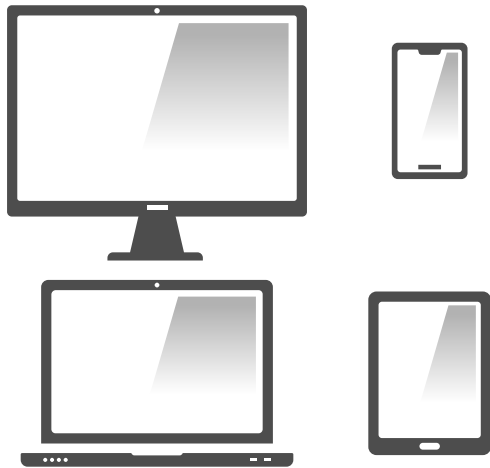

**IF YOU ARE VISUALLY IMPAIRED, THIS DOCUMENT CAN BE VIEWED IN
PDF FORMAT AT WWW.SUNRISEMEDICAL.CO.UK**

**FOR FURTHER INFORMATION ON THE FULL SPECIFICATION AND OPTIONS AND ACCESSORIES
PLEASE REFER TO THE ORDER FORM.
ALL INFORMATION IS SUBJECT TO CHANGE WITHOUT NOTIFICATION. PLEASE CONSULT SUNRISE
MEDICAL WITH ANY QUERIES YOU MAY HAVE.**

User Information

Intended use power wheel chairs:

Power wheelchairs are exclusively for a user who is unable to walk or has limited mobility, for their own personal use in- and outdoor.

When an Attendant Control Module is fitted, the Power Wheelchair may be operated by an assistant on behalf of the user.

When a Dual Control Module is fitted the Power Wheelchair may be operated by the user, or control may be switched to an assistant to operate on behalf of the user.

The maximum weight limit (includes both the user and any weight of accessories fitted to the wheelchair) is marked on the serial number label, which is affixed to the chassis of the chair.

The chair serial number is affixed also to the front page of the owners manual supplied with the wheelchair.

Warranty can only be taken on if the product is used under the specified conditions and for the intended purposes.

The intended lifetime of the wheelchair is 5 years. Please DO NOT use or fit any 3rd party components to the wheelchair unless they are officially approved by Sunrise Medical.

Area of application

The varieties of fitting variants, as well as the modular design, mean that it can be used by those who cannot walk or have limited mobility because of:

Indications

- Paralysis
- Loss of extremity (leg amputation)
- Extremity defect deformity
- Joint contractures/joint injuries
- Illnesses such as heart and circulation deficiencies, disturbance of equilibrium or cachexia as well as for elderly people who still have strength in the upper body.

Contraindications

The wheelchair shall not be used in case of:

- Perception disorder
- Imbalance
- Seating disability

When considering provision, please also note the body size, weight including the distribution of body weight, the user's physical and psychological constitution, the age of the user, their living conditions and their environment.

If in doubt a health care professional should be involved to ensure the user is not exposed to unacceptable risks.

Sunrise Medical is ISO 9001 and ISO 13485 certified, which ensures quality at all stages of the development and production of this wheelchair.



WARNING!



DO NOT USE YOUR WHEELCHAIR UNTIL THIS MANUAL HAS BEEN READ AND UNDERSTOOD.



As the manufacturer, SUNRISE MEDICAL, declares that this product conforms to the Medical Device Regulation (2017/745).



This symbol means Medical Device

Sunrise Medical declares that this product fulfils the performance requirements for a "Crash Test" to ISO 7176-19.

Notice to the user and/or patient: Any serious incident that has occurred in relation to the device should be reported to the manufacturer and the competent authority of the Member State in which the user and/or patient is established.

B4Me special adaptations

Sunrise Medical strongly recommends that in order to ensure that your B4Me product operates, and performs as intended by the manufacturer; all the user information supplied with your B4Me product is read and understood, before the product is first used.

Sunrise Medical also recommends that the user information is not discarded after reading it, but it is kept safely stored for future reference.

Medical Device Combinations

It may be possible to combine this Medical device with one or more other Medical Device or other product. Information on which combinations are possible can be found at www.Sunrisemedical.co.uk. All combinations listed have been validated to meet the General Safety and Performance Requirements, Annex I Nr. 14.1 of the Medical Device Regulation 2017/745.

Guidance on the combination, such as mounting, can be found at www.SunriseMedical.co.uk.

This chair is RoHs2 compliance (2011/65/EU)

The Serial Number and other important information may be found on a label situated on the right-hand side, main frame of the product.

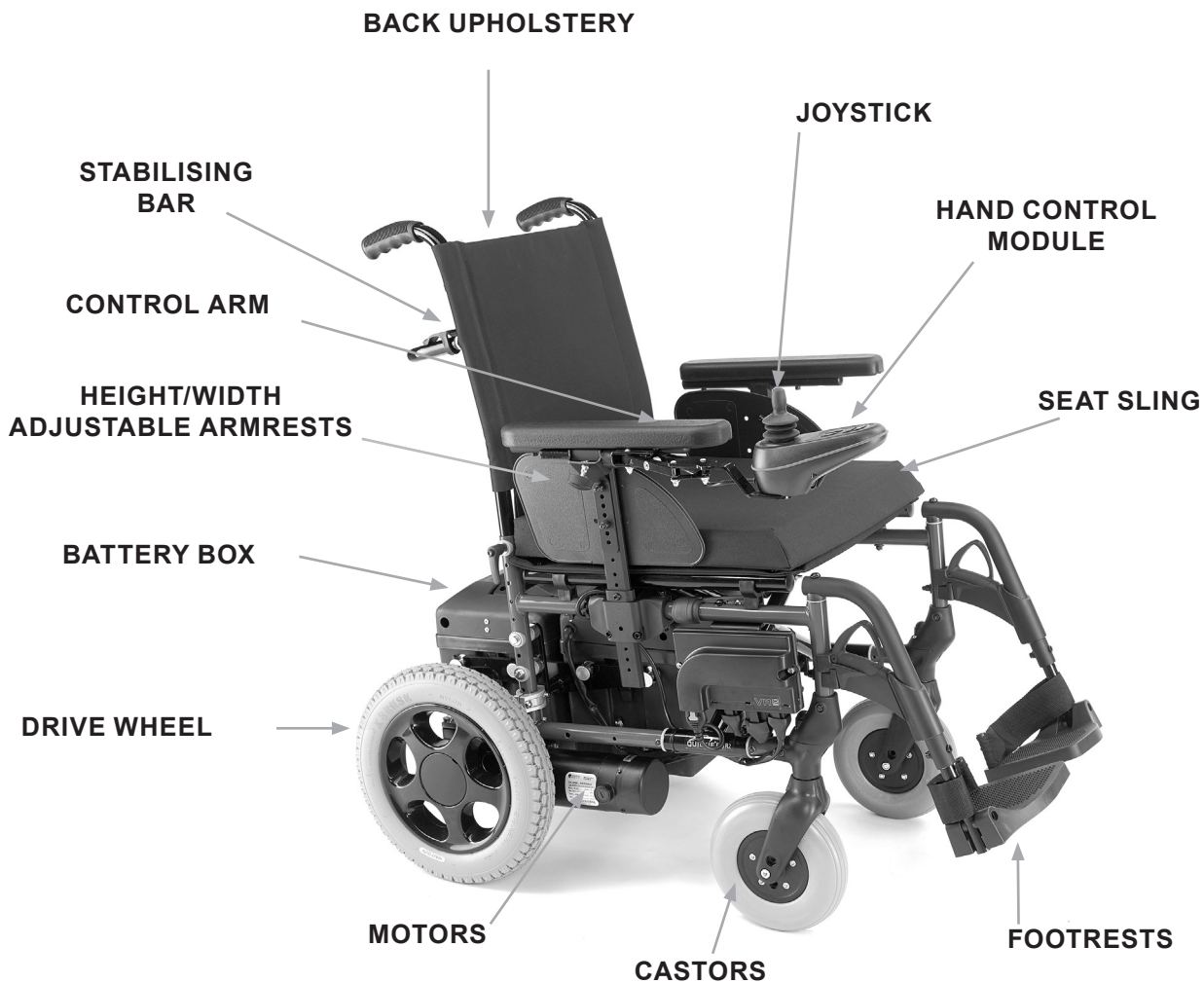

Due to its modular design, simplicity and wide range of adjustments, the Quickie F35 R2 is a perfect choice for easy service, refurbishment and recycle requirements.

As a part of our ongoing product improvement initiative, Sunrise Medical reserves the right to change specifications and design without notice. Further, not all features and options offered are compatible with all configurations of the wheelchair.

All dimensions are approximate and may be subject to change.

1.0 Your Wheelchair:	6	8.0 Troubleshooting The VR2 Hand Control:	21
2.0 How to use this manual:	6	9.0 Batteries and Charging:	23
2.1 Introduction:	6	9.1. Battery & Charger Specification:	23
2.2 Warranty:	6	9.2 Electrical fuses:	23
3.0 Label Explantation / Word definitions:	7	9.3 Batteries (Fig. 9.2 - 9.7):	23
3.1 Definitions of words used in this manual:	7	9.4 General battery information (Fig.9.8):	25
4.0 Safety:	8	9.5 Maintenance-free batteries:	25
4.1 General Warnings:	8	9.6 Battery care:	25
4.2 Features and options:	8	9.7 Maintenance-free battery care plan:	25
4.3 Preliminary checks:	8	9.8 General charger information:	26
4.4 Emergency braking:	8	9.9 Charger Specification:	26
4.5 Kerbs, (Fig 4.1):	8	9.10 Charger safety features:	26
4.6 Tyres:	9	9.11 Procedure for connecting the charger:	26
4.7 Freewheel device, (Fig.4.2):	9	9.12 Charger safety and caution notes:	26
4.8 EMC - Radio transmitting devices:	9	9.13 The range of your vehicle:	27
4.9 Sharp turns:	9	9.14 Common battery statements:	27
4.10 Weight limit:	9	10.0 Adjustments:	28
4.11 Hot surfaces:	10	10.1 Adjustment of the footrest (Fig. 10.1):	28
4.12 Road caution:	10	10.2 Adjustment of the armrests:	28
4.13 Adverse conditions:	10	10.3 Control Adjustment (Fig. 10.5):	28
4.14 Ramps:	10	10.4 Dual/Attendant control:	28
4.15 Transfer to and from the chair:	10	10.5 Parallel swing-away control (Fig.10.5):	29
4.16 Anti tips:	10	10.6 Programming:	29
4.17 Use on a slope:	11	11.0 Cleaning:	29
4.18 Gradients: ascents:	11	11.1 Cleaning General:	29
4.19 Gradients: descents:	11	11.2 Cleaning seating:	29
5.0 Assembly:	12	11.3 Cleaning control system:	29
5.1 Footplates	12	11.4 Speciality controls:	29
5.2. Anti-tip wheels (Fig.5.1):	12	12.0 Shipping & Storage Requirements:	30
5.3. Kerb climber (Fig. 5.2):	12	12.1 Storage temperature & humidity:	30
5.4. Batteries (Fig.5.3):	13	12.2 Special shipping requirements:	30
5.5. Wheels (Fig.5.4 & 5.5):	13	12.3 Medium to long term storage:	30
6.0 Using The Wheelchair:	14	13.0 Disposal:	30
6.1 Folding for transportation:	14	14.0 Specification sheets (EN 12184 & ISO 7176-15)	31
6.2 Opening the wheelchair:	14	15.0 Guarantee:	32
6.3 Option Elevating Legrest (Fig. 6.0 - 6.3)	14	16.0 Service Advice-Service History:	32
6.4 Adjusting the calf pad	14	17.0 Performance checks:	33
6.5 Slopes (Fig.6.4):	15	18.0 Nameplate	34
6.6 Transfers (Fig.6.5):	15		
6.7 Brake release, (Freewheel device):	15		
6.8. Tyre pressure:	16		
6.9 Mounting a kerb or step (Fig. 6.8):	16		
6.10 Dismounting the kerb (Fig. 6.8):	16		
7.0 VR2 Control System (Fig.7.1):	17		
7.1 On/Off button:	17		
7.2 Battery Level Indicator:	17		
7.3 Locking/unlocking the wheelchair:	17		
7.4 Operating the control joystick:	18		
7.5 Maximum speed/profile indicator:	18		
7.6 The horn button:	18		
7.7 Speed/Profile decrease button:	18		
7.8 Speed/Profile increase button:	18		
7.9 Charging and programming socket:	19		
7.10 VR2 dual control unit:	19		
7.10.1 Control button and indicator:	19		
7.10.2 Actuator button and LED:	19		
7.10.3 Maximum speed button and indicator:	20		

1.0 Your Wheelchair:

We at Sunrise Medical want you to get the best out of your F35 R2 wheelchair. This Owner's Manual will familiarise you with the chair and its features. It contains hints on everyday usage and general care in addition to information on the high quality standards which we adhere to and details about the guarantee.

Your wheelchair should be delivered fully configured for your use; there are a wide range of components and adjustments available on the F35 R2. For further information about these you should contact your Sunrise Medical authorised dealer.

Your wheelchair will reach you in excellent condition having been personally inspected before leaving our factory. Following the guidelines for maintenance and cleaning your wheelchair will maintain its first class condition and give you complete satisfaction.

The F35 R2 has been designed for use by an individual on a daily basis. It is suitable for both indoor and outdoor use (Class B). It is only intended for use as a pavement vehicle, but may also be used when crossing between pavements.

This vehicle has been designed for a single occupant of limited mobility up to the weight of 120Kg who has the cognitive, physical and visual ability to control the vehicle safely on a maximum slope of 18% (10°). If you are in any doubt as to the suitability of the power chair, contact your local Sunrise Medical approved supplier for clarification, prior to commencing use.

It is very important to read the relevant section of the owner's manual when making any minor adjustments. Consult the Technical Manual or your local Sunrise Medical authorised dealer for more complex adjustments.

If you have any queries about the use, maintenance or safety of your wheelchair, please contact your local approved Sunrise Medical service agent. If you do not know of an approved dealer in your area or have any other questions please write or telephone:

Sunrise Medical
Thorns Road
Brierley Hill
West Midlands
DY5 2LD
Phone: 0845 605 66 88
Fax: 0845 605 66 89
www.SunriseMedical.co.uk

Dealer signature and stamp

2.0 How to use this manual:

2.1 Introduction:

Please keep a note of your local service agent's address and telephone number in the space below.

In the event of a breakdown, contact them and try to give all relevant details so they can help you quickly.

The wheelchairs shown and described in this manual may not be exactly the same in every detail as your own model. However, all instructions are still entirely relevant, irrespective of detail differences.

NOTE: The manufacturer reserves the right to alter without notice any weights, measurements or other technical data shown in this manual. All figures, measurements and capacities shown in this manual are approximate and do not constitute specifications.

2.2 Warranty:

THIS GUARANTEE DOES NOT AFFECT YOUR LEGAL RIGHTS IN ANY WAY.

Sunrise Medical* provides a guarantee, as set out in the warranty conditions, for products to its customers covering the following.

Warranty conditions:

1. Should a part or parts of the product require repair or replacement as a result of a manufacturing and/or material fault within 24 months, then the affected part or parts will be repaired or replaced free of charge. The warranty will only cover manufacturing defects
2. To enforce the warranty, please contact Sunrise Medical Customer Service with the exact details of the nature of the difficulty. Should you be using the product outside the area covered by the Sunrise Medical customer service agent, repairs or replacement will be carried out by another agency as designated by the manufacturer. The product must be repaired by a Sunrise Medical designated Customer Service agent, (dealer).
3. For parts, which have been repaired or exchanged within the scope of this warranty, we provide a warranty in accordance with these warranty conditions for the remaining warranty period for the product in accordance with point 1.
4. For original spare parts which have been fitted at the customer's expense, these will have a 12 months guarantee, (following the fitting), in accordance with these warranty conditions.
5. Claims from this warranty shall not arise, if a repair or replacement of a product or a part is required for the following reasons:
 - a. Normal wear and tear, which include but is not limited to the following parts where fitted; batteries, armrest pads, upholstery, tyres, brakes shoes, ferrules, etc.
 - b. Any overloading of the product, please check the EC label for maximum user weight.

- c. The product or part has not been maintained or serviced in accordance with the manufacturer's recommendations as shown in the user instructions and/or the service instructions.
- d. Accessories have been used which are not specified as original accessories.
- e. The product or part having been damaged by neglect, accident or improper use.
- f. Changes/modifications have been made to the product or parts, which deviate from the manufacturer's specifications.
- g. Repairs have been carried out, before our Customer Service has been informed of the circumstances.

6. This guarantee is subject to the law of the country in which the product was purchased from Sunrise Medical^{*}





* Means the Sunrise Medical facility from which the product was purchased.

Additional Notes For Australia Only:

- i. For goods provided by Sunrise medical Pty Ltd in Australia, our goods come with a guarantee by Sunrise Medical that cannot be excluded under Australian Consumer Law.
- ii. You are entitled to a replacement or refund for a major failure and for compensation for any foreseeable loss or damage.
- iii. You are also entitled to have the goods repaired or replaced if the goods fail to be of acceptable quality and the failure does not amount to a major failure.
- iv. The benefits to you given by this warranty are in addition to your other rights and remedies under a law in relation to the goods to which the warranty relates.

3.0 Label Explanation / Word definitions:

3.1 Definitions of words used in this manual:

Word	Definition
 DANGER!	Advice to the user of Potential Risk of serious injury or death if the advice is not followed
 WARNING!	Advice to the user of a potential risk of injury if the advice is not followed
 CAUTION!	Advice to user that potential damage to equipment may occur if the advice is not followed
NOTE:	General advice or best practice
RWD	Rear Wheel Drive
	Reference To Additional Documentation

4.0 Safety:

If you follow the instructions given in this manual, you will enjoy many trouble-free years of use:

WARNING!

- This vehicle is not designed for use on the road except for crossing from one kerb to another.
- Load data always refers to one single person as operator.
- The wheelchair is authorised for use by one person or one seated person and their attendant if using a Dual or Attendant control unit.

WARNING!

4.1 General Warnings:

- Always ensure that your wheelchair is switched off before attempting to mount or dismount.
- Always ensure that you are able to operate all controls from a comfortable position. Paying attention to your posture is essential to ensure your continued comfort and well being.
- Always make sure that you can be seen clearly, especially if you intend using your wheelchair in poor light.
- This wheelchair has been built to match the needs of a particular user. If used by another user then it may need to be adjusted and reprogrammed.
- Do not let children or others use your wheelchair.
- Do not lift or hoist the wheelchair by any detachable parts such as leg rests, arm rests etc.

CAUTION!

4.2 Features and options:

Some of the options shown in this manual may not be available in your country and may also restrict the overall physical limits of the standard product (e.g. max. speed, user weight limit, etc.). Those limitations are marked on the order form, in the technical manual and in this owner's manual.

For further information please consult your Sunrise Medical authorised dealer.

DANGER!

4.3 Preliminary checks:

- You should not try to manoeuvre at full speed.
- If you have to make a sudden turn, slow down first using the joystick or the speed control knob.
- This is very important if you are going down a hill.
- Lack of attention to this point may result in your overturning the wheelchair.
- Always check that the wheelchair is switched off before trying to get in or out.
- Always check that you can operate all the controls from a comfortable seated position. It is essential to pay attention to posture in order to assure comfort and well-being.
- Always check that the freewheel device is switched off before setting the chair in motion.
- Always check that you can be seen clearly, especially if you are using the wheelchair in conditions of low visibility.

WARNING!

4.4 Emergency braking:

If power is cut by means of the ON/OFF button, braking will be immediate and total. This method of stopping is not recommended except for emergencies, since the stop will be extremely sudden.

4.5 Kerbs, (Fig 4.1):

- Always cross the road as rapidly as possible, since other vehicles may appear.
- Do not attempt to climb or to descend from, a kerb of more than 100 mm. height.
- Do not attempt to ascend high kerbs, steep slopes or cambers due to the risk of falling out of the chair or tipping over.
- Do not attempt to ascend any kerb in the vicinity of a drain cover, uneven surfaces, or gravel covering.
- Do not attempt to descend a kerb of more than 50 mm in forward position.
- Do not attempt to climb or descend any kerb at an oblique angle. Approach only at an angle of 90° with at least 500mm run-up.

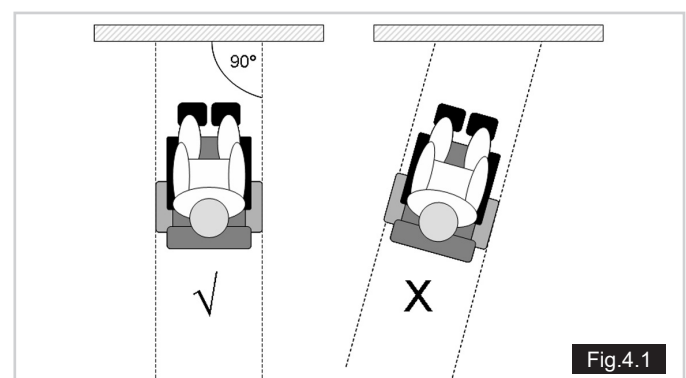

4.6 Tyres:

The tyres of a wheelchair suffer wear depending on how much the chair is used. Check them regularly, especially for inflation pressure, according to the service instructions in this manual.

WARNING!

NEVER inflate the tyres with the air hose of a service station.

WARNING!

4.7 Freewheel device, (Fig.4.2):

Also see Fig.6.7

- Only use this function to push the chair manually from one spot to another.
- Keep in mind that while the freewheel system is in operation, the chair is without a braking system.
- Disengaging the motor causes an error message to appear in the control, which is indicated when the LED display flashes rapidly.
- For safety reasons the wheelchair can no longer be moved using the joystick.
- Do not operate the freewheel device whilst seated in the wheelchair.
- The freewheel device should only be operated by a person who has the strength and agility to be able to fully manoeuvre the wheelchair safely, during freewheel.

WARNING!

4.8 EMC - Radio transmitting devices:

When operating two-way radio, walkie-talkies, C.B., amateur radio, public mobile radio and other powerful transmitting devices the wheelchair should be brought to a halt and turned off. The operation of cordless, mobile telephones and cell phones including hands-free devices is permitted but if abnormal operation of the wheelchair is encountered then the chair must be brought immediately to a halt and turned off.

NOTE: the electrical systems of the wheelchair may disturb the performance of alarm systems in retail shops.

DANGER!

4.9 Sharp turns:

Full speed turns should not be attempted. If you need to turn sharply you must reduce your speed with the joystick or speed setting. This is particularly important when travelling across or down a slope. Disregarding this advice could lead to your wheelchair tipping over.

DANGER!

4.10 Weight limit:

- The user plus items carried should never exceed a total weight of 120 kgs.
- Never use this chair for weight training if the total weight (user plus additional weights) exceed a total weight of 120 kgs.
- Exceeding the weight limit is likely to damage the seat, frame or fasteners and may cause severe injury to you or others from chair failure
- Exceeding the weight limit will void the warranty Wheelchair motors.



4.11 Hot surfaces:

WARNING!

- After prolonged use, the motors will produce heat, which is radiated through the motors' outer casing. Do not touch the motors' outer casing for at least 30 minutes after using the wheelchair, to allow it to cool.
- Not only motors can become hot during the operation of the chair, the upholstery material and armrests may heat up when standing in the sun.

DANGER!

4.12 Road caution:

- Please show the utmost consideration for the other traffic on the road.
- Remember that the last thing a car or lorry driver expects to see is a wheelchair backing off the kerb into the road.
- If in any doubt, do not risk crossing the road until you are certain that it is safe.
- Always cross the road as quickly as possible; there may be other traffic.

WARNING!

4.13 Adverse conditions:

Please be aware that when driving your wheelchair in adverse conditions, e.g. on wet grass, mud, ice, snow or other slippery surfaces, you may experience a reduction in the grip and traction of your wheelchair. We recommend you take extra precautions in these conditions, particularly on hills and slopes; your wheelchair could become unstable or skid causing possible injury. Extreme variances in temperature may trigger the self protect mechanism in the control system. If this occurs the control system will temporarily shut down to prevent damage to the electronics or the chair.

WARNING!

When you are using a Powered Scooter or Wheelchair, take extra care with loose or long items of clothing. Moving parts, such as wheels, can be potentially dangerous or even fatal if clothing becomes entangled.

WARNING!

4.14 Ramps:

- When using a ramp, please ensure that it is capable of taking the combined weight of the power chair and yourself.
- If a ramp is being used to load a chair into a vehicle, please ensure the ramp is properly secured to the vehicle.
- Always approach the ramp head-on and exercise caution.
- Please ensure your ramp is suitable for the product you are transporting.

WARNING!

Maximum ramp angle is 10° (18%)

4.15 Transfer to and from the chair:

Sunrise Medical recommend that you consult your healthcare professional for assistance in developing your personal front or side transfer technique to best suit your needs and avoid any personal injury.

WARNING!

4.16 Anti tips:

- Make sure that anti tips are not damaged or worn before using your chair.
- Check the anti tips are functioning correctly on a regular basis.
- Attendants must be aware of the location of the anti tips to prevent feet being trapped underneath causing injury.
- **Attendants** - Do not stand on the anti tips, this could cause the wheelchair to become unstable.

 **WARNING!**

4.17 Use on a slope:

Your wheelchair has been designed and tested to allow its use on slopes or gradients of up to 10° (18%).

- Before attempting to climb or descend a slope or a kerb, caution should be taken when using weight shift options (e.g. powered recline) of the seat and/or your body for a counter balance weight.
- To improve stability lean forward when driving uphill, with the seat and back in an upright position.
- Alternatively sit in an upright position when travelling in a forward, downhill direction or recline the seat backwards. We strongly recommend that you return back to an upright lowered position before attempting to climb or descend a slope.
- Failure to do this may cause the wheelchair to become unstable.
- If you are in any doubt about the capabilities of your wheelchair on a slope then do not attempt to drive up or down the slope/kerb; try to find an alternative route.

 **WARNING!**

4.18 Gradients: ascents:

- When going uphill, keep the chair moving.
- Steer by moving the joystick from side to side.
- If you have stopped on a hill, you should start slowly.
- On a RWD chair, if necessary lean forward to prevent the tendency for the front wheels to lift.

 **WARNING!**

4.19 Gradients: descents:

- On descents, it is important not to let the wheelchair accelerate beyond its normal level of ground speed.
- It is safer to proceed slowly down steep descents (below the speed of 5kph) and stop, if any anxiety arises regarding directional control.
- If the chair picks up speed, centre the control to slow it or to stop all forward movement, then restart slowly and do not allow the speed to increase.
- The rider plus item should never exceed a total weight of 120kg.
- Before you use the chair, carefully check the functionality.
- If you discover any chair malfunction, take it to be repaired or reset. Your dealer can help you to find the fault and correct it.
- Make sure batteries are charged. Do not use the chair when battery is low. The chair may come to a sudden, unexpected stop.
- Be aware that there is a point during every transfer when the wheelchair seat is not below you.
- Use extra care when you drive your chair in reverse. If one of the wheels hits an obstacle, you could lose control of the chair or fall out.
- Never use your chair on a slope unless you are sure you can do so without losing traction.
- Lift the chair only by non-detachable parts of the main frame.
- Never short-circuit electrical connections as you could cause an explosion.
- Do not use this chair if any of the tyres are under or over-inflated.
- When using mobile phones you should switch off the chair to avoid causing electromagnetic radiation.

5.0 Assembly:

5.1 Footplates

The footplates can be flipped up to make it easier to transfer to/from the chair.

Lower leg length:

For users with longer legs, the leg support can be lowered to the appropriate level by using the screws (1). Loosen the screws, push the tubes to the desired position and then re-tighten the screws (see section on torque). There must always be a minimum gap of 25mm between the footplates and the ground, (Fig. 8.0).

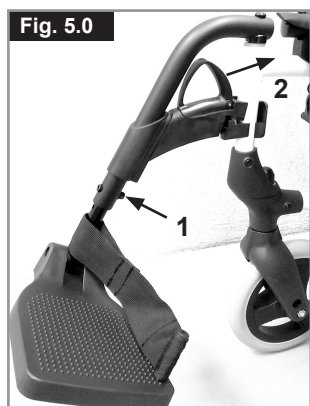

Footrests and Latch

The legrests can be swung inwards under the seat sling or outwards.

When fitting the legrests, the footrests must be pointing inwards or outwards. Then rotate the legrest inwards, until it locks into place. To remove, pull the lever (2), swing the footplate inwards or outwards and then lift the legrest out. Make sure that the legrest is locked into place correctly.

⚠ CAUTION!

- The legrests must not be used to lift or to carry the wheelchair.
- When getting on or off the wheelchair, do not use the footboards.

These should be flipped up beforehand or the footrest should be swung to the outside as far as possible.

5.2. Anti-tip wheels (Fig.5.1):

The anti-tip tube is fixed to the frame tube by a mounting pin.

To fit the anti-tip wheels:

- Slide the anti-tip tube through the hole located on top of the motor.
- Align the holes in the anti-tip and frame tube.
- Insert the mounting pin.
- Repeat for the other side.
- Reverse the procedure for disassembling.

NOTE: Anti-tips wheels may interfere with kerbs when mounting or dismounting. Follow the instructions in sections 6.13 & 6.14.

⚠ WARNING!

Never use the wheelchair without the anti-tip wheels fitted.

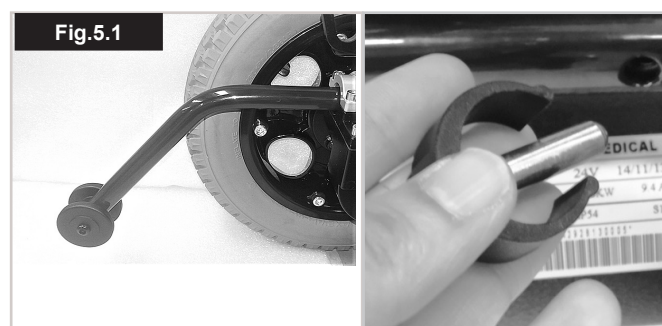

5.3. Kerb climber (Fig. 5.2):

- Fit the oval connecting clamps over each lower frame tube and loosely tighten the studs, (1), using a 5.0 mm. Allen key.
- Insert the support brackets, (2), into each clamp.
- Fit the kerb climber into the supports.
- Insert the fastening clip, (3), through the holes in the kerb climber tube and support brackets.
- Tighten the studs fully, (1).

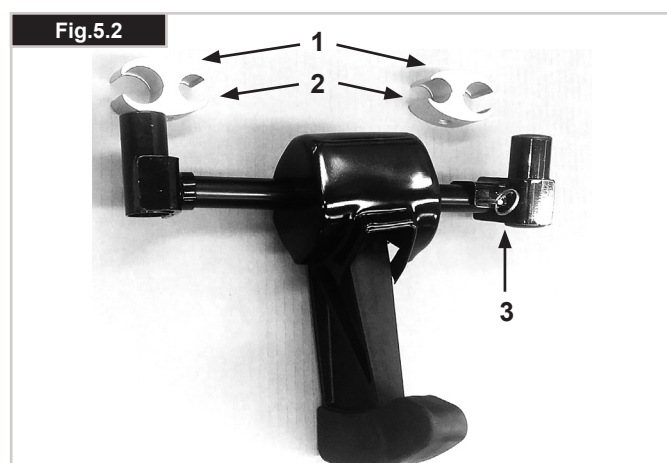

5.4. Batteries (Fig.5.3):

Also see Chapter 9.0.

- Firstly, take the battery box with the power loom fitted. Position it so that the power loom is on your right. This will make connection much easier.
- Lean the side supports of the battery box on the rails.
- Push the battery box fully forwards on the rails until it locks into place at the end of the rails.
- Now fit the next battery box onto the rails
- Connect the two plugs on the left side of the battery cases together.
- Ensure that the connections are secure, then connect the front battery to the controls.
- To remove the batteries, reverse the procedure. Disconnect the battery from the control and then disconnect the batteries from each other. Push the battery cases upwards slightly until they disengage, and then pull them out along the rails.



5.5. Wheels (Fig.5.4 & 5.5):

If it is necessary to remove the wheels, to repair a damaged tyre for example, proceed as follows:

WARNING!

All wheels are safety critical items. If you are unsure about performing these tasks, please contact your approved Sunrise Medical dealer.

Front castor wheel (Fig.5.4):

- Use a 7.0 mm. Allen wrench to remove the wheel axle from the fork.
- Remove the damaged wheel.
- When the wheel has been repaired, follow the reverse procedure to refit.



Rear drive wheel (Fig.5.5):

- Use a flat-bladed screw driver to remove the centre cap.
- Loosen the large stud slightly using a 19.0 mm. socket wrench.
- Elevate the wheel and secure using blocks.
- Remove the stud & ease the wheel off.
- Reverse the procedure to refit.
- Tighten the stud to a torque of 25Nm

Note: The rear wheels are designed as separate rims and can be disassembled to simplify changing the tube or tyre.

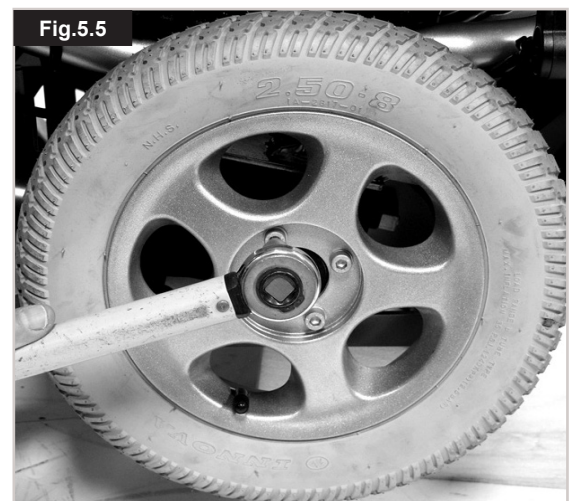

6.0 Using The Wheelchair:

WARNING!

Parts of the wheelchair are heavy. Please use correct lifting techniques.

If you are unsure about lifting or removing any assemblies, or performing any other task requiring physical effort, get someone to help you who can manage the task.

6.1 Folding for transportation:

Remove the batteries as described in section 5.5 and Chapter 9.0

- Lift the batteries out using the handles on the lid of each battery box.
- Take hold of the seat upholstery in the middle and pull it upward until the unit is fully folded.
- To lift the chair when folded, please use the upper parts of the side frame tubes and back handles.

6.2 Opening the wheelchair:

Press downwards on the upper tubes of the cross frame until the chair is completely unfolded. Now put the batteries in place.

WARNING!

Never lift the wheelchair by the armrests or foot rests, since they are detachable parts and harm could be done to the user or to the wheelchair.

6.3 Option Elevating Legrest (Fig. 6.0 - 6.3)

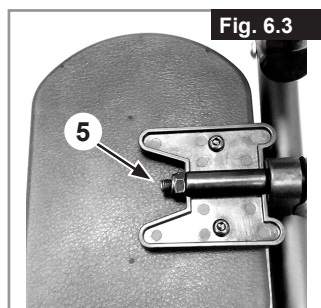
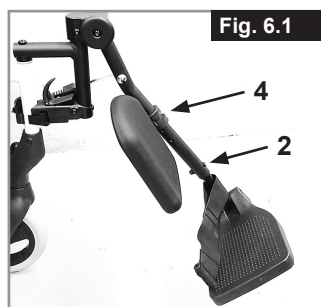
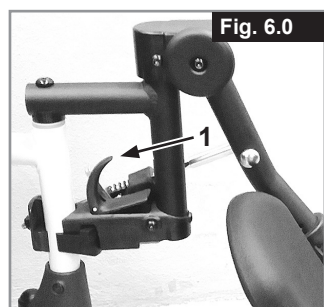

To remove, pull the lever (1), swing the footplate outwards and then lift the legrest out.

Height Adjustment:

The lower leg length can be adjusted by releasing the screw (2). Adjust the suitable height and tighten the screw again.

CAUTION!

The distance between the footplate and the ground must be at least 40 mm.

Angle Adjustment:

Press the lever (3) downward with one hand while supporting the legrest with the other hand to take the load off. When a suitable angle is achieved, let go of the lever and the legrest will lock into one of the preset positions.

CAUTION!

- Keep hands clear of the adjustment mechanism between, the frame and the movable parts of the footrest while elevating or lowering the footrest.
- The footrests should not be used to lift or to carry the wheelchair.
- Risk of trapping fingers!
- When moving the footrest up or down, do not put your fingers in the adjusting mechanism between the moving parts of the footrest.
- When getting on or off the wheelchair, do not use the footboards.

These should be flipped up beforehand or the footrest should be swung to the outside as far as possible.

6.4 Adjusting the calf pad

The calf pad can be adjusted as follows:

Height: Open bolt (4 Fig. 6.1) and move the clamping piece to the desired position. By rotating the clamping piece also the angle can be adjusted.

Width: Open bolt (5) and rotate the position of the plastic part behind the pad, to get the desired position.

CAUTION!

Always make sure that the fasteners are secure. Make sure that the legrest is locked into place correctly.

6.5 Slopes (Fig.6.4):

The following instructions explain how to manoeuvre correctly on steep ramps and slopes, especially in the course of descent.

WARNING!

- If your chair has a manual recline back, we strongly recommend that you bring the backrest into an upright position and set the seat tilt to the level position.
- If you stop on an incline, start off slowly and, if necessary, lean forward to counteract the tendency of the front wheels to rise.
- On descents it is important not to allow the wheelchair to exceed normal speed. Indeed, the safest course is to go down steep hills slowly and to stop immediately if you have any doubts about the steering.
- If the chair gathers speed, move the joystick to its central position to slow down, or stop completely.
- Start off again slowly and do not allow speed to increase. Make sure the automatic brakes are engaged.
- Climbing or descending a slope with the automatic brakes disengaged can be dangerous.

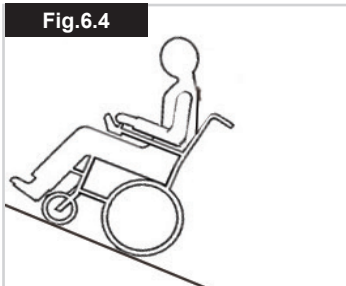

6.6 Transfers (Fig.6.5):

Always position the wheelchair close to the place where the transfer will be carried out. It is important that the controller is turned OFF, so that the wheelchair will not move throughout the procedure. The wheelchair is highly stable owing to its weight. Do not stand up on the footrests at any time during the transfer.



6.7 Brake release, (Freewheel device): (Fig. 6.6).

To put the wheelchair into freewheel:

- Turn the lever on the back of each motor outwards.
- The wheelchair is now in freewheel.
- The drive wheels will turn freely.

To put the wheelchair into drive:

- Turn the lever on the back of each motor inwards.
- The wheelchair is now in drive.
- The drive wheels will reconnect with the motors and will only turn when power is applied.

WARNING!

- The Brake release, (freewheel), is only to be used in an emergency power breakdown situation e.g. Where a large distance has to be covered to get the user home or into a safe environment.
- Brake release can also be used if a complete and catastrophic loss of power such as control system failure or battery failure has occurred.
- Brake release should not be habitually used as a means of transporting the user as if in a manual chair.
- When the power chair is functioning normally, the brake release should only be used to park or store the unoccupied wheelchair.
- Please remember that you have no braking facility when the Brake release, (freewheel), levers are moved from the normal drive position to the freewheel position.
- Always ensure an attendant is with you when bringing the chair into the freewheel mode.
- The wheelchair must never be left with one or both levers in the freewheel position.



6.8. Tyre pressure:

It is important to check inflation pressure regularly, along with the state of wear of the tyres. The maximum pressure recommended for the front wheels is 36 psi (2.5 bars), while for the rear wheels it is 40 psi (2.7 bars).

DANGER!

Never inflate the tyres with a service station air pump. It is recommended that you use a manual pump or a pressure regulator (manometer).

6.9 Mounting a kerb or step (Fig. 6.8):

Always approach a kerb at 90 degrees, Approach the kerb (step) head on driving forwards slowly and steadily and always at a 90 degrees angle.

As the kerb climber or castor makes contact with the kerb (step), the wheelchair should be moving slowly. Small kerbs can be climbed from a standstill.

Apply sufficient power to the motors to lift the front of the chair up onto the kerb (step) and then apply slightly more power and speed so that the drive wheels climb the kerb (step) smoothly and without hesitation. As far as possible, keep the joystick in the straight forward position.

In accordance to the ground clearance, the maximum obstacle height possible to climb is 50 mm (100 mm with kerb climber).

WARNING!

The approach speed and process can vary depending on your wheelchair performance and castor wheel choice.

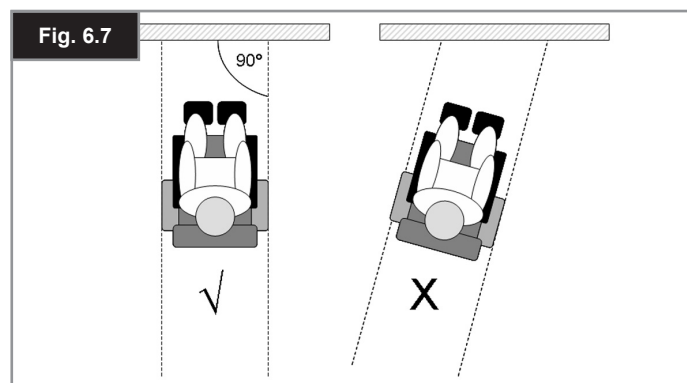

6.10 Dismounting the kerb (Fig. 6.8):

- Reverse the chair slowly and carefully until both rear wheels are on the edge of the kerb, again in a 90 degrees position to the kerb.
- Reverse as slowly as possible off the kerb with the rear wheels. You will feel more secure if you can lean forward, but if you can't, don't worry, the wheelchair is extremely stable. As long as you stay within its limitation, you will be quite safe.
- The front of the chair will naturally follow down the kerb as you continue to drive slowly backwards.

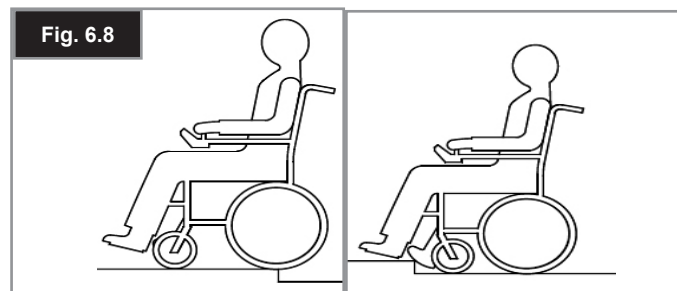

7.0 VR2 Control System (Fig.7.1):

Your wheelchair is controlled by the Joystick. This regulates the power & speed of the wheelchair. The Joystick determines the speed and direction of the wheelchair.

7.1 On/Off button:

The On/Off button applies power to the control system electronics, which in turn supply power to the wheelchair's motors.

WARNING!

Do not use the on/off button to stop the wheelchair unless there is an emergency. (If you do you may shorten the life of the wheelchair drive components).

7.2 Battery Level Indicator:

The battery gauge shows you that the wheelchair is switched on. It also indicates the status of the wheelchair. Refer to Fig.7.1.

7.3 Locking/unlocking the wheelchair:

The VR2 control system can be locked to prevent unauthorised use. The locking method is via a sequence of key presses and joystick movements as detailed below.

To lock the wheelchair;

- While the control system is switched on, depress and hold the On/Off button.
- After 1 second the control system will beep. Now release the On/Off button.
- Deflect the joystick forwards until the control system beeps.
- Deflect the joystick in reverse until the control system beeps.
- Release the joystick, there will be a long beep.
- The wheelchair is now locked.

To unlock the wheelchair;

- Use the On/Off button to switch the control system on. The maximum speed/profile indicator will be rippling up and down.
- Deflect the joystick forwards until the control system beeps.
- Deflect the joystick in reverse until the control system beeps.
- Release the joystick, there will be a long beep.
- The wheelchair is now unlocked.

WARNING!

To avoid unexpected or unintentional movement of the wheelchair and to conserve battery power, it is recommended that the control system is switched Off when drive or seating adjustments are not being used.



Fig. 7.1

7.4 Operating the control joystick:

When engaging the main On/Off button, allow a few seconds prior to moving the joystick. This allows the system to self check. If you move the joystick too soon, the battery level indicator display will not illuminate until the joystick is released.

If the joystick is off centre at the time of switching on, after 5 seconds a system error will occur.

Whilst this is not harmful to your wheelchair, you will need to switch off and then back on to clear the system.

Note: This is a safety feature to prevent unintended movement.

Proportional control summary:

Steering.

To steer the chair simply move the joystick knob in the desired direction. The further you move the joystick from the central position, the faster the wheelchair will travel in the direction the joystick is pushed.

Look ahead while you drive, not at the controls.

Stopping.

When the joystick returns to its central position, the brakes will activate automatically.

Braking Distance.

On flat ground, braking distance is approximately equal to the length of the wheelchair. Going downhill the braking distance may be slightly longer.

Forward/Reverse.



It is important that you stop the wheelchair before you change direction from forward to reverse.



Always turn the controller off before you transfer in or out of the wheelchair.

7.5 Maximum speed/profile indicator:

This is a gauge which shows the maximum speed setting for the wheelchair or if the control system is programmed for drive profile operation, the selected drive profile. This gauge also indicates if the speed of the wheelchair is being limited or if the control system is locked.

7.6 The horn button:

The horn will sound while this button is depressed.

7.7 Speed/Profile decrease button:

This button decreases the maximum speed setting or, if the control system is programmed for drive profile operation, selects a lower drive profile.

7.8 Speed/Profile increase button:

This button increases the maximum speed setting or, if the control system is programmed for drive profile operation, selects a higher drive profile.

Remember that only with practice will you become a competent driver. Find a safe, hazard free environment to practice controlling the wheelchair and familiarise yourself with the controls and functions.

7.9 Charging and programming socket:

(Fig.7.2)

WARNING!

- This socket should only be used for programming and charging the wheelchair.
- This socket should not be used as a power supply for any other device.
- Connection of other electrical devices may damage the control system or affect the EMC performance of the wheelchair.

See Section 9.0 about charging.

The programming socket will enable an approved Sunrise Medical authorised dealer to re-programme your chair and also gain useful information when tracing any faults. When the chair leaves the factory, the parameters of the controller are set to default.

To programme the controller you need a special programming device (handheld or PC software), which is available to your Sunrise Medical authorised dealer.

WARNING!

Programming the controller of the wheelchair is only allowed through authorised personnel trained by Sunrise Medical. Incorrect controller settings could cause driving outside the safe limits and could result in damage or injury.

NOTE: Sunrise Medical does not accept responsibility for damages which result from unexpected movement or stopping of the wheelchair due to inappropriate programming or unauthorised use of the wheelchair.



Fig. 7.2

7.10 VR2 dual control unit:

7.10.1 Control button and indicator:

This shows which joystick has control. If the red wheelchair light is on the wheelchair occupants joystick has control. If the green attendant light is on the dual attendant systems joystick has control. The button is used to transfer control between the two choices, (Fig.7.3-7.4).

7.10.2 Actuator button and LED:

All VR2 dual attendant systems have an actuator button fitted as standard. If the VR2 is programmed with no actuators then this button has no function, (Fig.7.3-7.4).

Wheelchairs with one actuator:

Depressing the actuator button once will enter actuator adjustment mode. This will be indicated by the illumination of both actuator LED's. Actuator adjustment can then be made by deflecting the joystick forwards and backwards. To re-enter drive mode, depress either the actuator button or the speed button.



Fig. 7.3

7.10.3 Maximum speed button and indicator:

This shows the maximum speed setting for the wheelchair when the dual attendant system has control. There are five settings - setting 1 is the slowest speed and setting 5 is the highest speed. The speed setting is changed with the speed button, (Fig.7.3-7.4).

If the control system is programmed for drive profile operation, then the dual attendant system speed adjuster will only adjust the speed within the selected profile. Changing between drive profiles can only be achieved using the VR2 main joystick.

WARNING!

To avoid unexpected or unintentional movement of the wheelchair and to conserve battery power, it is recommended that the control system is switched Off when drive or seating adjustments are not being used.

Note: Always move the chair with care.

If the programming of the attendant drive profile (s) needs adjustments to make it more convenient for the attendant and/or the person sitting in the wheelchair, please contact your Sunrise Service agent for adaptation.

If the direction of movement of the directional attendant control needs to be altered, please contact your authorised Sunrise Medical dealer for adaptation.

WARNING!

Do not attempt to program the wheelchair yourself. Always consult a qualified health care professional. Contact your Sunrise medical approved dealer for details.



Fig. 7.4

8.0 Troubleshooting The VR2 Hand Control:

Always consult your Sunrise Medical authorised dealer when a diagnostic fault has appeared on your hand control.

The battery gauge and maximum speed/profile indicator show the status of the control system, (Section 7.0, Fig.7.1).

Battery Gauge is steady - This indicates that everything is OK.

Battery Gauge flashes slowly - The control system is functioning correctly but the batteries need charging as soon as possible.

Battery Gauge steps up - The wheelchair batteries are being charged. You will not be able to drive the wheelchair until the charger is disconnected and you have switched the control system off and on again.

Battery Gauge flashes rapidly (even with the joystick released)

The control system safety circuits have operated and the control system has been prevented from moving the wheelchair.

This indicates a system trip. i.e. the VR2 has detected a problem somewhere in the wheelchairs electrical system.

- Switch off the control system.
- Make sure that all connectors on the wheelchair and the control system are mated securely.
- Check the condition of the battery.
- If you can't find the problem, try the self help guide on the next page.
- Switch on the control system again and try to drive the wheelchair.
- If the safety circuits operate again, switch off and do not try to use the wheelchair.
- Contact your Sunrise Medical authorised dealer.

Self help guide, (Fig.8.1).

See next page.

If a system trip occurs you can find out what has happened by counting the number of bars on the battery gauge that are flashing.

Go to the number on the list which matches the number of flashing bars and follow the instructions.

Slow or sluggish movement - If the wheelchair does not travel at full speed or does not respond quickly enough and the battery condition is good, check the maximum speed setting. If adjusting the speed setting does not remedy the problem then there may be a non hazardous fault. Consult your Sunrise Medical authorised dealer.

Speed/Profile Indicator ripples up and down - This indicates the control system is locked, refer to section 7.3 for details on how to unlock the control system.

Speed/Profile Indicator flashes - This indicates that the speed of the wheelchair is being limited for safety reasons. The exact cause will depend on the build of the chair but usually indicates that the seat is elevated.

Actuator LED flashes - This indicates that the actuators may be inhibited in one or both directions.

Fault code	Possible cause
	The batteries need charging, or there is a bad connection to the battery. Check the connections to the battery. If the connections are good, try charging the batteries.
	The left hand motor has a bad connection. Check the connections to the left hand motor.
	The left hand motor has a short circuit to a battery connection. Contact your Sunrise Medical authorised dealer.
	The right hand motor has a bad connection. Check the connections to the right hand motor.
	The right hand motor has a short circuit to a battery connection. Contact your Sunrise Medical authorised dealer.
	The wheelchair is being prevented from driving by an external signal. One possibility is that the battery charger is plugged in.
	A joystick fault is indicated. Make sure that the joystick is in the centre position before switching on the control system.
	A control system fault is indicated. Make sure the control system connections are secure.
	The parking brakes have a bad connection. Check the parking brake and the motor connections. Make sure that the control system connections are secure.
	An excessive voltage has been applied to the control system. This is usually caused by a poor battery connection. Check the battery connections.
	<div style="display: flex; align-items: center;"> <div style="margin-right: 10px;">+ S</div> <div> <p>S = Speed indicator LED's</p> <p>A communication fault is indicated. Make sure that the joystick cable is securely connected and not damaged.</p> </div> </div>
	<div style="display: flex; align-items: center;"> <div style="margin-right: 10px;">+ A</div> <div> <p>A = Actuator LED's</p> <p>An actuator trip is indicated. If more than one actuator is fitted, check which actuator is not working. Check the actuator wiring.</p> </div> </div>

Fig. 8.1

9.0 Batteries and Charging:

WARNING!



Please read the owner's manual supplied with the charger carefully. The general procedures and effects for the interference with the chair and the batteries remain valid.

- Do not expose any part of the battery to direct heat (i.e. naked flame, gas fire).
- When charging always place your charger on a hard surface in a room with good ventilation.
- You should not charge your batteries in outdoor conditions.

For details see sections 9.8 - 9.12

9.1. Battery & Charger Specification:

Batteries:

24 V (2x12 V) / 40 Ah., Gel Type-maintenance-free

Dimensions: 197 x 165 x 170 mm

Capacity at the discharge time 34 Ah/5 h

Optional 24 V (2x12 V) / 50 Ah., Gel Type-MF

Dimensions: 197 x 165 x 170 mm

Optional 24 V (2x12V) / 50Ah Gel Type MF

Dimensions: 228 x 139 x 235mm

Charger:

Connector: 3 pin "Cannon" type

Charger: 24 Vd.c. 8 A

9.2 Electrical fuses:

To prevent the wheelchair from becoming overloaded, fuses been built into the battery looms. The fuses automatically isolate the battery from the wheelchair wiring and control systems in the event of an electrical short circuit.

If you suspect that the fuses have blown, contact your Sunrise Medical authorised dealer as soon as possible, who will carry out a full diagnostic to determine the cause of the original the fault.

WARNING!

Do not attempt to change the fuses yourself.
Do not attempt to by-pass the fuse as this would be very dangerous.

Contact your Sunrise Medical authorised dealer as soon as possible.

9.3 Batteries (Fig. 9.2 - 9.7):

- Firstly, take the battery box with the power loom fitted. Position it so that the power loom is on your right. This will make connection much easier.
- Lean the side supports of the battery box on the rails.
- Push the battery box fully forwards on the rails until it locks into place at the end of the rails.
- Now fit the next battery box onto the rails.
- Connect the two plugs on the left side of the battery cases together.
- Ensure that the connections are secure, then connect the front battery to the controls.
- To remove the batteries, reverse the procedure. Disconnect the battery from the control and then disconnect the batteries from each other. Push the battery cases upwards slightly until they disengage, and then pull them out along the rails.

DANGER!

Do not short circuit the battery terminals. Remember that spanners or jewelry are conductive and if dropped across the battery terminals may cause severe burns and/or explosion!

WARNING!

- Batteries are heavy. Use correct lifting techniques when removing them from the wheelchair and from the battery boxes.
- Always use the handles or straps provided to lift the batteries.

To refit the batteries please reverse the above procedure.

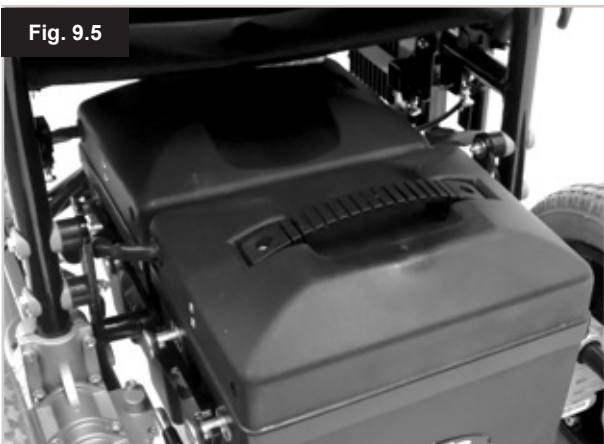
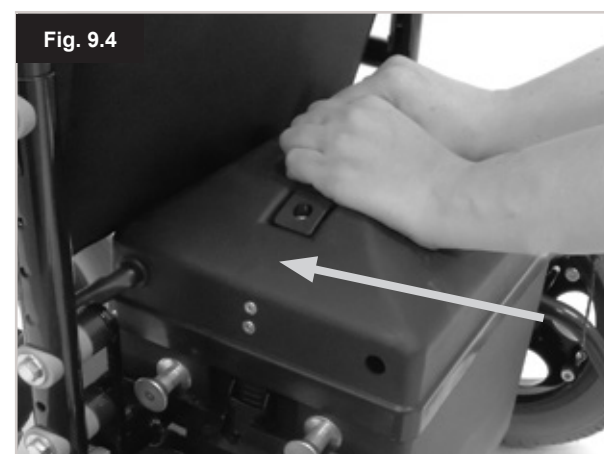

9.4 General battery information (Fig.9.8):

Batteries are the power source for almost all of the modern mobility products available today. The design of batteries used in mobility products is significantly different to the batteries used to start a car for example. Car batteries are designed to release a large amount of power over a short period of time, whilst mobility batteries (commonly called deep cycle batteries) release their power evenly, over a long period of time. Therefore, due to the lower production volumes and increased technological requirements, mobility batteries are typically more expensive.

Commonly two 12 volt batteries are used together in a mobility product, giving a total voltage of 24 volts. The size of the battery (e.g. its available power) is expressed in amps per hour e.g. 80 A/hr. The higher the number, the bigger the battery size, weight and, potentially, the greater the distance you can travel. Sunrise Medical only fit as standard maintenance-free batteries into these types of wheelchairs.

9.5 Maintenance-free batteries:

This type of battery uses a method of carrying the electrolyte commonly referred to as 'gel', that is held within the battery case. As the name implies, no maintenance is required other than regular charging. You can safely transport this type of battery without fear of acid spilling. Furthermore, they are approved for transportation on aircraft, trains and ships.

9.6 Battery care:

Below is set out a battery care plan for maintenance-free batteries. This has been agreed between Sunrise Medical and the battery manufacturers, to enable you to get the best out of your batteries. If a different care plan is followed, this may result in lower than expected performance from your mobility vehicle.

9.7 Maintenance-free battery care plan:

- Only use an approved Sunrise Medical charger compatible with the vehicle to be charged.
- Charge your batteries every night, regardless of the amount of use your mobility device has had during the day.
- Do not interrupt the charging cycle.
- If your mobility device is not required for use, it should remain connected to the charger until required. This will not damage your batteries, as long as the mains socket/plug is left switched on. Turning the mains socket/plug off, but leaving the mains cable plugged in will eventually deplete your battery charge.
- If you leave your vehicle for an extended period (more than 15 days) charge the batteries fully and then disconnect the main battery lead.
- Failure to allow for recharge will damage the batteries and can lead to shortened distances and premature failure.
- Do not top up the charge of your batteries during the day. Wait until the evening for a full overnight charge.
- As a general rule, maintenance-free batteries take longer to fully charge than lead acid batteries.
- The battery terminals need to be checked regularly for signs of corrosion. If any corrosion is apparent, then clean the terminals completely (a wire brush is ideal) and re-grease the terminal using Vaseline petroleum jelly, not ordinary grease. Ensure that the terminal nut and bolt, cable clip and exposed cable are completely covered with jelly.
- Following all the points above should result in a healthier battery, greater range for the vehicle user and a longer life for your batteries.
- Return the batteries back to Sunrise Medical or directly to the battery manufacturer for recycling, when they no longer hold charge.

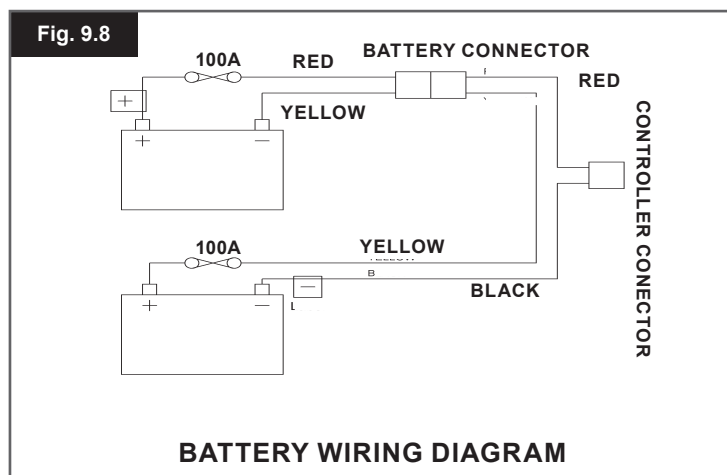

9.8 General charger information:

The external charger has been designed to charge two 12 V Gel type batteries connected in series (= 24 V).

9.9 Charger Specification:

WARNING!

Only use chargers for cyclic batteries, Gel-Type with 24V/8A output nominal max.



For more information about the charger operation, consult the instructions provided with the charger.

NOTE: If the charger is not connected to the control it does not output charge voltage.

WARNING!

It is possible that the charger's metallic box may slightly raise in temperature due to use.

9.10 Charger safety features:

The chargers have features which prevent hazards or accidents occurring as a result of connecting batteries the wrong way round, overheating caused by fault conditions or attempting to charge wrong voltage batteries.

The majority of charger sizes are electrically double insulated and no earth connection is required. Some larger sizes may be electrically earthed and this will be clearly stated on the label.

The 3 pin UK mains input plug contains a replaceable fuse. The rating of this fuse is shown on the charger label.

WARNING!

Always replace with the same type and size of fuse as specified. Fitting of different fuses can result in damage to the charger or failure of the charger to operate properly.

If your charger has been specified for use in Continental Europe it will contain a European two pin plug which does not have a fuse. In this case the fuse is located in the fascia panel of the charger.

9.11 Procedure for connecting the charger:

- The wheelchair can be charged via the charger socket at the front of the VR2 remote control, (Fig. 9.9).
- Ensure the VR2 is switched off.
- First, connect the charger to the VR2.
- Then, connect the charger to the mains supply by means of the mains plug and switch on.
- Do not leave the charger connected to the battery with the mains disconnected or switched off. This could result in damage to your battery being caused by deep discharge over a period of time.
- Always switch off at the mains before disconnecting the batteries.

9.12 Charger safety and caution notes:

WARNING!

- The charger is designed for indoor use. Do not use outdoors or expose to rain, snow, spray or moisture.
- When buying replacement batteries or charger always consult your Sunrise Medical service agent.
- The charger may be used with other brands of Gel type batteries, subject to written confirmation from the Technical Department of Sunrise Medical.



9.13 The range of your vehicle:

The batteries give the chair a range of approximately 25 kilometres. Most manufacturers of mobility products state the range of their vehicles either in the sales literature or within the Owner's Manual. The range stated sometimes differs from manufacturer to manufacturer even though the battery size is the same. Sunrise Medical measure the range of their vehicles in a consistent and uniform manner, but variances still occur due to motor efficiencies and overall product load weight.

The range figures are calculated to I.S.O. Standard 7176. Part 4: Wheelchair Energy Consumption Theoretical Range.

This test is carried out in controlled conditions with new, fully charged batteries, on a level test surface and a user weight of 100 kg. The range figures stated should be seen as a theoretical maximum and could be reduced if any single, or combination, of the following circumstances occur:

- User weight heavier than 100 kg.
- Batteries whose age and condition are less than perfect.
- The terrain is difficult e.g. very hilly, sloping, muddy ground, gravel, grass, snow and ice.
- The vehicle climbs kerbs regularly.
- The ambient temperature is very hot or very cold.
- Incorrect tyre pressures in one or more tyres.
- Lots of start/stop driving.
- Also thick pile carpets within the home can affect range.
- Use of additional power consumption options (e.g. light, actuators, etc.).

The battery sizes available on each Sunrise Medical product should give sufficient range to cope with the majority of customer's lifestyles.

9.14 Common battery statements:

Over the years, battery technology has moved forward but, unfortunately, some of the advice given on battery care has not. This has resulted in a number of confused and at times contradictory instructions on the 'best' way to care for your batteries.

This section will help to dispel some of these myths and legends.

To reduce the risk of damage to electric plug and cord, pull by the plug rather than the cord when disconnecting the charger. Make sure the cord is located so that it will not be stepped on, tripped over or otherwise subjected to damage or stress. An extension cord should not be used unless absolutely necessary. Use of an improper extension cord could result in a risk of fire and electric shock. If any extension cord must be used, make sure the pins on the plug of the extension cord are the same number, size and shape as those of the plug on the charger; and that the extension cord is properly wired and in good electrical condition.

10.0 Adjustments:

10.1 Adjustment of the footrest (Fig. 10.1):

To adjust the height of a footrest:

Loosen the screw, using a 10.0mm spanner and 5.0mm Allen key. Set the footrest at the desired height, then tighten the screw in the hole.

NOTE: Make sure that the screws are tightened securely.

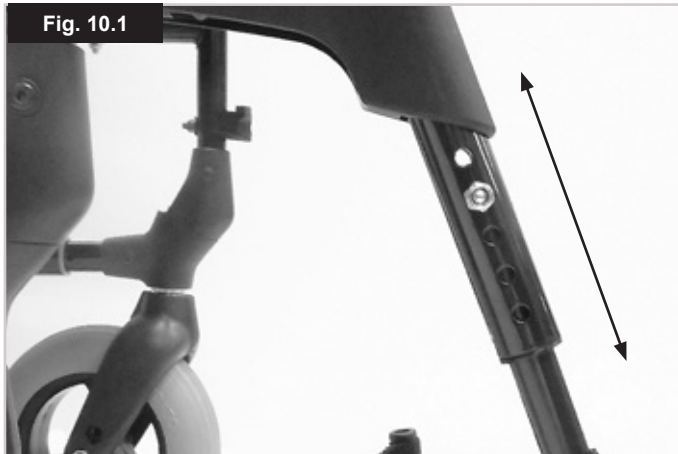

10.2 Adjustment of the armrests:

Tool Height Adjustable Armrest

Installation: Slide the arm post into the receiver, located on the wheelchair frame, until it stops

Height adjustment:

Slide the arm rest post out of the receiver.

Adjust the position of the height adjustment bracket (1) by removing the screw (2) and moving it to the desired position. Re-fit the screw and tighten it.

Slide the arm rest post back into the receiver, (Fig. 10.2).

Armpad Position:

The armpad position can be adjusted by releasing the screws (3), then moving the arm pad to the desired position. Re-tighten the screws, (Fig. 10.2).

Adjusting Armrest Receiver

The tightness of the armrest receiver can be adjusted (tightened /loosened) by means of the 2 screws (1) - (Fig. 10.3).

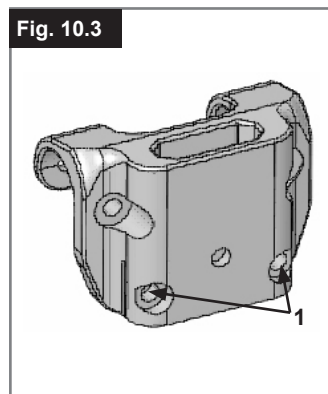
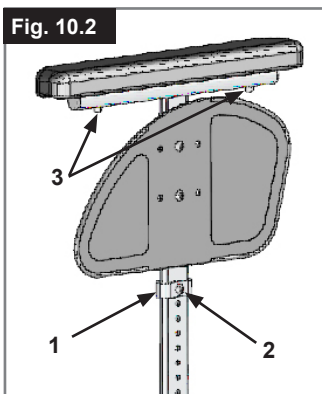

Height-adjustable armrests

To adjust the height, pull the lever (1) and push the armrest to the desired height. Afterwards make sure that the lever (1) locks back into position. Removing the armrest is carried out in the same way.



To remove the sideguard completely, push the lever (2). When fitting the sideguard, the lever (2) must also be pulled.

Always make sure that the sideguard locks into position correctly in the receiver. (Fig. 10.4).

10.3 Control Adjustment (Fig. 10.5):

The control can be adjusted to various positions by pushing it along the armrest. The control can be moved by turning the lever below the arm pad anti-clockwise, reposition the controller and secure by turning the lever clockwise to tighten.

⚠ WARNING!

- Do not replace the joystick knob with any unauthorised item. It may cause hazardous operation and loss of control of the chair.
- It is important that the joystick boot is replaced if it is torn or brittle; failure to do so could cause substance damage to the controller and unexpected movement of the chair.
- Ensure that you always have comfortable access to the controls whilst the chair is moving and make sure that the controller is fixed securely to the chair.



10.4 Dual/Attendant control:

⚠ WARNING!

- Ensure that you set the speed of the attendant control to a speed that you can comfortably follow.
- Always turn off the power to the controller when leaving the user in the chair. (See sections 7.11 - 7.15).

10.5 Parallel swing-away control (Fig.10.5):

WARNING!

- Before adjusting the swing-away arm, switch off the controller to avoid accidental displacement of the joystick which would cause unwanted movement of your wheelchair.
- Keep your fingers and clothing, etc. clear while operating the swing-away mechanism.
- Be aware that the width of your chair has increased if the swing-away arm is out and you may not get between certain obstacles.
- Do not hang any items on or over the parallel swing-away remote assembly as this could damage the swing-away mechanism.
- When transferring to and from the wheelchair do not use the remote as a means of support.
- Keep fingers, clothing, etc. clear of the swing-away mechanism at all times.
- Ensure the power is switched off while adjusting the parallel swing-away arm.
- Only operate the wheelchair at low manoeuvring speed when the parallel swing-away is in use, (Fig.10.5).

10.6 Programming:

When the chair leaves the factory, the parameters of the controller are set to default. However, if any alterations are required, then you should contact your dealer, where a specialist can carry out this work.

Note: A programmer or a PC-based software program with the appropriate connecting lead are required to program the wheelchair.

WARNING!

- Never attempt to programme the wheelchair yourself.
- Programming the controller of the wheelchair is only allowed through authorised personnel trained by Sunrise Medical. Incorrect controller settings could cause driving outside the safe limits and could result in damage or injury.



11.0 Cleaning:

11.1 Cleaning General:

- The wheelchair should be wiped over once per week with a slightly damp, not wet, cloth and any fluff or dust that has accumulated around the motors should be blown or dusted away.
- Make sure that you dry all parts of your wheelchair if it becomes wet or damp after cleaning or if it is used in a wet or damp atmosphere.
- It is important that should the wheelchair be used by more than one person it is cleaned thoroughly to ensure there is no cross infection. You should use a proprietary disinfectant for this task. Please pay attention to the manufacturer's instructions of the disinfectant you are using.
- Inspect the upholstery/seating for tears, dents, wearing or slackening of upholstery particularly near to metal as this could result in poor posture or lower levels of comfort and pressure relief.

11.2 Cleaning seating:

All parts/accessories such as swing-away trays should be cleaned with a damp cloth.

All lateral supports, headrest, armrests, side-guards, calf pads, lap belts and kneepads should be cleaned with a damp cloth.

CAUTION!

Do not use a hose or a pressure washer to clean your chair.

11.3 Cleaning control system:

Clean the control system and the joystick with a cloth dampened with diluted detergent. Be careful when cleaning the joystick.

CAUTION!

Never use abrasive or spirit based cleaners.

11.4 Speciality controls:

Ensure that joysticks (all variants) are cleaned with a mild disinfectant and a cleaning cloth to avoid any cross infection possibilities.

WARNING:

Ensure the controller is switched off before cleaning.

12.0 Shipping & Storage Requirements:

12.1 Storage temperature & humidity:

Storage Temperature: Min: -40°C Max: 65°C

Relative Humidity (non-condensing): Min:5% Max: 95%

12.2 Special shipping requirements:

The wheelchair may be transported by road, rail, sea or air and the batteries conform to IATA regulations.

CAUTION!

Before you travel, please contact the appropriate carrier. The travel operator will be able to supply details of any special requirements/instructions.

- Ensure that any detachable parts are secured with your mobility aid or separately packed and labelled so they do not get lost during loading and unloading.
- Take this Owner's Manual with you.
- The carrier will need to refer to the following sections.
- How to lock/unlock the Joystick, (Section 7.3).
- How to disconnect the batteries, (Section 9.3, Fig.9.1 to 9.9).
- How to disconnect the drive, (Section 6.10).

12.3 Medium to long term storage:

When storing your wheelchair for long periods of time (in excess of one week), follow these simple instructions:

Fully charge the wheelchair for at least 24 hours. Disconnect the batteries or battery boxes.

WARNING!

Never store your wheelchair;

- Outside.
- In direct sunlight, (plastic parts may discolour).
- Near a source of direct heat.
- In a damp environment.
- In a cold environment.
- With the batteries/battery boxes connected, (even if the controller is switched off).

Avoiding all of the above will minimise battery deep cycle discharge and extend battery lifetime.

When returning the wheelchair to use, please reconnect the batteries/battery boxes and charge the wheelchair for at least 24 hours before use.

13.0 Disposal:

The symbols below mean that in accordance with local laws and regulations your product should be disposed of separately from household waste. When this product reaches the end of its life, take it to the local collection point designated by local authorities. The separate collection and recycling of your product at the time of disposal will help conserve natural resources and ensure that it is recycled in a manner that protects the environment.

Ensure you are the legal owner of the product prior to arranging for the product disposal in accordance with the above.

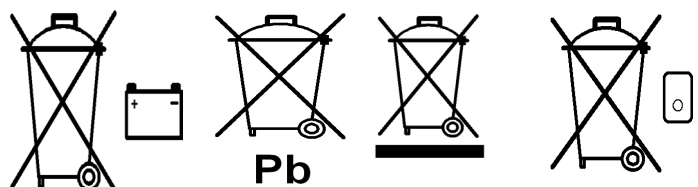

14.0 Specification sheets (EN 12184 & ISO 7176-15)

Sunrise Medical S.L.
 Polígono Bakiola, 41
 48498 Arrankudiaga – Vizcaya
 España
 Tel.: +34 (0) 902142434
 Fax: +34 (0) 946481575
 www.sunrisemedical.com

Operating temperature: - 25°C to 50°C
 Storage temperature: -40°C to 65°C
 Moisture resistance: IPx4
 No restrictions on humidity and air pressure

Model: Quickie F35 R2



Maximum occupant mass:
 120kg user weight.

The wheelchair Quickie F35 R2 conforms to the following standards:

a) requirements and test methods for static, impact and fatigue strengths (ISO 7176-8)

b) power and control systems for electric wheelchairs requirements and test methods (ISO 7176-14)

c) climatic test in accordance with ISO 7176-9

d) requirements for resistance to ignition in accordance with ISO 7176-16

e) the product is specified as a Class B power chair

f) all materials used on this product conform to EN1021 parts 1 and 2.

ISO 7176-15	MIN.	MAX.	COMMENTS
Overall length (Inc. Leg rest)	1060mm	1060mm	70° hangers
Overall width	600mm		
Total mass (with batteries)		67.1kg	
Folded Length	860mm*	1050mm	* Without legrests
Folded Width	335mm		
Folded Height	645mm*	920mm	*Without backrest
Mass of the heaviest part	-	34.0kg*	*Batteries, Legrests and Footrests removed
Static stability downhill	-	10°	
Static stability uphill	-	10°	
Static stability sideways	-	10°	
Energy consumption (max. range)	-	25km	6kph motor & 100kg user
Dynamic stability uphill	-	10°	Max. Safe Slope = 10° (18%)
Obstacle climbing (with kerb climber)	50mm	100mm*	* With Kerb Climber
Max. speed forward		6kph	
Min. brake distance from max. speed	-	-	Depends on programming
Seat plane angle	0°	3°	Set without tools
Effective seat depth	-	430mm	
Effective seat width	430mm	520mm	Via armrests
Seat surface height at front edge	-	510mm	
Back rest angle		8°	
Back rest height		425mm	
Footrest to seat distance	420mm	490mm	
Leg to seat surface angle	70°	-	
Armrest to seat distance	180mm	300mm	
Min. turning radius	900mm		70° Hanger
Nominal battery voltage	24V		Deep Cycle Mobilty
Battery Capacity	40 Ah	50Ah	Deep Cycle Mobilty
Battery cut-off voltage	16V		
Battery fusible links	-	100A	In-line fuse on each battery
User Weight		120kg	
EN 12184	MIN.	MAX.	COMMENTS
Max. kerb height	50mm	(100mm)	(With kerb climber)
Turning space/Reversing width	900mm	-	
Speed control operation force		2N	
Direction control operation force		1N	

NOTE: Some of the options and measures may be not available in all countries.

15.0 Guarantee:

SUNRISE MEDICAL guarantees this product for two years as from the date indicated on the invoice, receipt or delivery note. For products containing batteries, the battery warranty is 6 months. This warranty covers parts in need of replacement, labour and transport.

In warranty claims the user must submit the product and the purchase invoice as proof of delivery date.

This warranty does not cover:

NORMAL WEAR AND TEAR, e.g. on upholstery, tyres, inner tubes, rims, wheels, fabric, etc.

ACCIDENTS, e.g. bent structures, scratches, flat tyres, etc.

IMPROPER USE and damage caused by users who weigh more than the weight limit indicated in the user's manual.

LACK OF MAINTENANCE and failure to follow the conservation instructions in the user's manual.

MODIFICATIONS or **REPAIRS** carried out by persons not authorised by Sunrise Medical.

PRODUCTS WITH NO INVOICE OR SERIAL NUMBER (when appropriate).

Life Expectancy

We estimate a life expectancy of 5 years for this product, provided that:

It is used in strict accordance with the intended use as set out in this document.

All service and maintenance requirements are met.

The estimated life expectancy can be exceeded if the product is carefully used and properly maintained.

The life expectancy can also be considerably reduced by extreme or incorrect usage.

The fact that we estimate a life expectancy for this product does not constitute an additional warranty.

Servicing Agents Only:

Any parts required should be obtained from Sunrise Medical only either through our web site or by direct contact with our Customer Service or Service department.

Do not use unauthorized parts or carry out unauthorised modifications.

DEALER STAMP

16.0 Service Advice-Service History:

This section is designed to assist you in keeping a record of any service and repairs to your wheelchair. The service Agent will complete this section and return the manual to you.

NOTE: Please contact your local Sunrise medical approved servicing agent for any warranty, service or repair work required.

Model				
Serial Number				
Year	1	2	3	4
Service dates				
Controller				
On/Off switch				
Output plug				
Operation				
Dynamic braking				
Programmable configuration				
Batteries				
Physical Damage				
Connections				
Discharge tests				
Wheels/Tyres				
Wear				
Pressure				
Bearings				
Whel nuts				
Motors				
Wiring				
Noises				
Connections				
Brakes				
Brushes				
Freewheel Device				
Chassis				
Condition				
Steering				
Upholstery				
Seat				
Back				
Armrests				
Electric's				
Condition of loom				
Connections				
Test run				
Forward				
Reverse				
Emergency stop				
Left run				
Right run				
Up/Down slope				
Over obstacle				
Parking brake				

17.0 Performance checks:

After performing any maintenance or repairs on the wheelchair you must make sure that it is functioning correctly before it is used.

- Visually inspect the wheelchair to make sure the legrests, armrests etc are correctly positioned and attached to the wheelchair and all fasteners are sufficiently tightened.
- Make sure that the backrest is correctly fitted and adjusted.
- Make sure that all of the cushions are in place.
- Switch on the hand control – Do the lights flash? This signifies that there is a fault in the electronic system. Refer to section 8.0 for basic troubleshooting.
- Perform the parking brake check.
- Drive the wheelchair in each of the drive profiles, (if installed), to make sure the wheelchair performs as it did before.













WARNING!













If you are in any doubt about the performance requirements of your wheelchair contact your Sunrise Medical authorised dealer.

NOTE: Only the tasks in the GREEN boxes below should be attempted by the user. If you are in any doubt, please contact your Sunrise Medical authorised dealer.

Maintenance and Inspection Schedule	Daily	Weekly	Quarterly	Six month	Annually
Check battery level indicator and charge if necessary.	*				
Check the joystick of the hand control is not bent or damaged.	*				
Ensure all removable parts are securely fastened.	*				
Parking brake test.		*			
Check tyres and inflate.		*			
Ensure the fasteners on the seat depth adjustment are tight,		*			
Ensure all cables and connectors are sound and are tidy and out of the way.		*			
Clean wheelchair and upholstery.		*			
Battery terminal inspection – Remove any corrosion and apply Vaseline.			*		
Check upholstery, seating, headrests, armpads and calfpads for wear.				*	
Complete inspection, safety check and service should be made by a Sunrise Medical authorised dealer.					*

18.0 Nameplate

F35-R2	Product Name/SKU Number.
	Maximum safe slope with anti-tip tubes fitted, Depends on wheelchair setting, posture and physical capabilities of the user.
	Maximum user weight.
	Load Maximum.
	Maximum speed.
	Maximum axle loading.
	CE Mark.
	User's Guide.
	Indicates electrical / electronic equipment must be disposed of in accordance with the WEEE regulation.
	XXXX-XX-XX Date of manufacture.
	Serial number.
	This symbol means Medical Device.
	Manufacturer's address.
ISO 7176-19:2008	Crash tested according to ISO 7176-19:2008.

	 Sunrise Medical GmbH Kahlbachring 2-4 D-69254 Malsch / Germany	 2021-04-30
TYPE:	POWER WHEELCHAIR	 208210510901
F35-R2	ISO 7176-19:2008	FIN-Nr: CO71255
 120 kg	 max 188 kg	 max 6 km/h
 max 10°	 max 135 / 88 kg	 
 		



Sunrise Medical S.r.l.
Via Riva, 20 – Montale
29122 Piacenza
Italia
Tel.: +39 0523 573111
Fax: +39 0523 570060
www.SunriseMedical.it

Sunrise Medical AG
Erlenauweg 17
CH-3110 Münsingen
Schweiz/Suisse/Svizzera
Fon +41 (0)31 958 3838
Fax +41 (0)31 958 3848
www.SunriseMedical.ch

Sunrise Medical AS
Delitoppen 3
1540 Vestby
Norge
Telefon: +47 66 96 38 00
post@sunrisemedical.no
www.SunriseMedical.no

Sunrise Medical AB
Neogatan 5
431 53 Mölndal
Sweden
Tel.: +46 (0)31 748 37 00
post@sunrisemedical.se
www.SunriseMedical.se

MEDICCO s.r.o.
H – Park, Heršpická 1013/11d,
639 00 Brno
Czech Republic
Tel.: (+420) 547 250 955
Fax: (+420) 547 250 956
www.medicco.cz
info@medicco.cz
Bezplatná linka 800 900 809

Sunrise Medical Aps
Mårkærvej 5-9
2630 Taastrup
Denmark
+45 70 22 43 49
info@sunrisemedical.dk
Sunrisemedical.dk

Sunrise Medical Australia
11 Daniel Street
Wetherill Park NSW 2164
Australia
Ph: +61 2 9678 6600
E: enquiries@sunrisemedical.com.au
www.SunriseMedical.com.au

Sunrise Medical
North American Headquarters
2842 Business Park Avenue
Fresno, CA, 93727, USA
(800) 333-4000
(800) 300-7502
www.SunriseMedical.com



Sunrise Medical GmbH
Kahlbachring 2-4
69254 Malsch/Heidelberg
Deutschland
Tel.: +49 (0) 7253/980-0
Fax: +49 (0) 7253/980-222
www.SunriseMedical.de

Sunrise Medical
Thorns Road
Brierley Hill
West Midlands
DY5 2LD
England
Phone: 0845 605 66 88
Fax: 0845 605 66 89
www.SunriseMedical.co.uk

Sunrise Medical S.L.
Polígono Bakiola, 41
48498 Arrankudiaga – Vizcaya
España
Tel.: +34 (0) 902142434
Fax: +34 (0) 946481575
www.SunriseMedical.es

Sunrise Medical Poland
Sp. z o.o.
ul. Elektronowa 6,
94-103 Łódź
Polska
Telefon: + 48 42 275 83 38
Fax: + 48 42 209 35 23
E-mail: pl@sunrisemedical.de
www.Sunrise-Medical.pl

Sunrise Medical B.V.
Groningehaven 18-20
3433 PE NIEUWEGEIN
The Netherlands
T: +31 (0)30 – 60 82 100
F: +31 (0)30 – 60 55 880
E: info@sunrisemedical.nl
www.SunriseMedical.nl

Sunrise Medical HCM B.V.
Vossenbeemd 104
5705 CL Helmond
The Netherlands
T: +31 (0)492 593 888
E: customerservice@sunrisemedical.nl
www.SunriseMedical.nl
www.SunriseMedical.eu
(International)

Sunrise Medical S.A.S
ZAC de la Vrillonnerie
17 Rue Mickaël Faraday
37170 Chambray-Lès-Tours
Tel : + 33 (0) 247554400
Fax : +30 (0) 247554403
www.sunrisemedical.fr

