

U.S. Suggested Retail Price List

January 2014

Phone: 1-800-336-7684

Fax: 704-882-0751

www.snugseat.com

PO Box 1739 Matthews, NC 28106

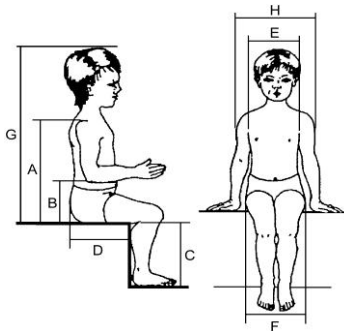

A (Back height)	_____
B (Arm height)	_____
C (Lower leg length)	_____
D (Seat depth)	_____
E (Chest width)	_____
F (Seat width)	_____
G (Height)	_____
H (Shoulder width)	_____
Age	_____
Weight	_____

Standard Features



- One size frame
- Tilt in space - 45°
- Suspension System
- Blue, Red, Green, or Pink Cushion Set
- Accepts two seat sizes for maximum growth potential
- 180° Turnable seat platform
- Sun Shade

Frame and Seat Measurements

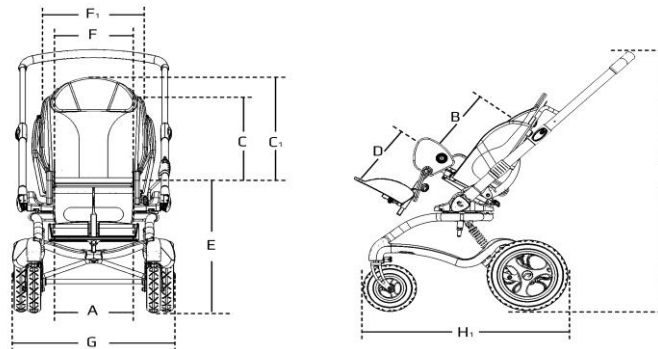

	Seat Size 1	Seat Size 2
Seat width (A) - Without hip supports	11¾"	13¾"
Seat width (A) - Between hip supports	7"-8½"-10¼"	9"-10½"-12½"
Seat width between knee supports	11"	13"
Seat depth (B)	7"-11¼"	9½"-15½"
Back height at shoulders (C)	10½"-16½"	15½"-20¾"
Back height (C1)	17-22"	21¼"-26½"
Lower leg length (D)	5½"-11¾"	5½"-14½"
Seat height above floor (E)	20½"	20½"
Back width, inside (F)	11¾"	14"
Back width, outside (F1)	17¾"	20½"
Frame width (G)	23"	23"
Frame length (H1)	29"	29"
Height, push brace (I)	39¼, 40½, 41¾"	39¼, 40½, 41¾"
Foot plate, width x depth	12½ x 8"	12½ x 8"
Frame length, folded	35½"	35½"
Tilt angle	45°	45°
Height, folded	19¼"	19¼"
Weight, frame	29½ lb	29½ lb
Weight, seat	12 lb	14½ lb
Max load	88 lb	88 lb

Account No. _____ Drop Ship: _____
 Date: _____ Name _____
 P.O. Number: _____ Address _____
 Buyer: _____ City _____
 Marked For: _____ State _____ Zip _____
 E Mail: _____ Tel. _____ Fax _____

Phone: 1-800-336-7684

Fax: 704-882-0751

www.snugseat.com

PO Box 1739 Matthews, NC 28106

	Description	Color	Size	Part No.	Price
	HCPCS - E1233 Stingray Tilt-In-Space Frame With 7" Casters and quick release 12½" rear wheels				
	Solid tires, individual wheel locks			8702212	2,395 <input type="checkbox"/>
	Solid tires, individual wheel locks & hand brakes*			8702211	2,645 <input type="checkbox"/>
	Solid tires, central wheel locks			8702222	2,435 <input type="checkbox"/>
	Solid tires, central wheel locks & hand brakes*			8702221	2,755 <input type="checkbox"/>
	*Quick release wheels not available with hand brakes				

*Όλες οι αναγραφόμενες τιμές δεν περιλαμβάνουν μεταφορικά έξοδα και Φ.Π.Α

Seating Systems

Adjustable seat depth and height adjustable back.

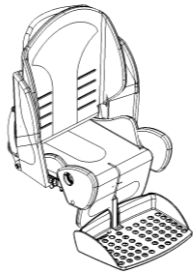

	HCPCS		
Seat, size 1	E2292	X8711000	400 <input type="checkbox"/>
Back, size 1	E2291	X8712000	495 <input type="checkbox"/>
Seat, size 2	E2292	X8721000	400 <input type="checkbox"/>
Back, size 2	E2291	X8722000	495 <input type="checkbox"/>



REQUIRED OPTION



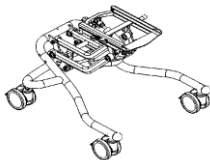





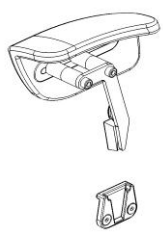
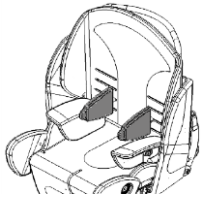
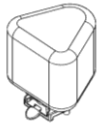

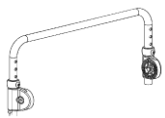

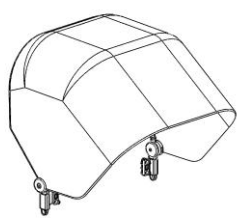

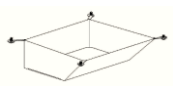
Fully Reclining Back	E1014	X8702000	395 <input type="checkbox"/>
Contoured Seat and Back Cushions set size 1, blue		X8730511	NC <input type="checkbox"/>
Contoured Seat and Back Cushions set size 1, red		X8730512	NC <input type="checkbox"/>
Contoured Seat and Back Cushions set size 1, green		X8730513	NC <input type="checkbox"/>
Contoured Seat and Back Cushions set size 1, pink		X8730515	NC <input type="checkbox"/>
Contoured Seat and Back Cushions set size 2, blue		X8730521	NC <input type="checkbox"/>
Contoured Seat and Back Cushions set size 2, red		X8730522	NC <input type="checkbox"/>
Contoured Seat and Back Cushions set size 2, green		X8730523	NC <input type="checkbox"/>
Contoured Seat and Back Cushions set size 2, pink		X8730525	NC <input type="checkbox"/>











High-low:v Indoor Frame - Size 1 seat only	Size 1	8911871-02	1,735 <input type="checkbox"/>
High-low:v Indoor Frame - Size 1 or 2 seat	Size 2	8911872-02	2,150 <input type="checkbox"/>
Push brace		8910545	150 <input type="checkbox"/>
Push brace, angle adjustable		8910555	375 <input type="checkbox"/>

	Description	Color	Size	Part No.	Price
Accessories					
	HCPCS - K0108				
	Footrest rod, elevating, short		8¼"	X8711100	110 <input type="checkbox"/>
	Footrest rod, elevating, long		11"	X8712100	110 <input type="checkbox"/>
	HCPCS - K0040				
	Foot plate, angle adjustable		one size	X8710010	95 <input type="checkbox"/>
	Footstraps, plastic lock		one size	36-8596	35 <input type="checkbox"/>
Hip Supports - HCPCS E0956					
	Hip supports, fixed, blue, right		Size 1	8720231_R	105 <input type="checkbox"/>
	Hip supports, fixed, blue, left		Size 1	8720231_L	105 <input type="checkbox"/>
	Hip supports, fixed, red, right		Size 1	8720232_R	105 <input type="checkbox"/>
	Hip supports, fixed, red, left		Size 1	8720232_L	105 <input type="checkbox"/>
	Hip supports, fixed, green, right		Size 1	8720233_R	105 <input type="checkbox"/>
	Hip supports, fixed, green, left		Size 1	8720233_L	105 <input type="checkbox"/>
	Hip supports, fixed, pink, right		Size 1	8720235_R	105 <input type="checkbox"/>
	Hip supports, fixed, pink, left		Size 1	8720235_L	105 <input type="checkbox"/>
	Hip supports, fixed, blue, right		Size 2	8720241_R	105 <input type="checkbox"/>
	Hip supports, fixed, blue, left		Size 2	8720241_L	105 <input type="checkbox"/>
	Hip supports, fixed, red, right		Size 2	8720242_R	105 <input type="checkbox"/>
	Hip supports, fixed, red, left		Size 2	8720242_L	105 <input type="checkbox"/>
	Hip supports, fixed, green, right		Size 2	8720243_R	105 <input type="checkbox"/>
	Hip supports, fixed, green, left		Size 2	8720243_L	105 <input type="checkbox"/>
	Hip supports, fixed, pink, right		Size 2	8720245_R	105 <input type="checkbox"/>
	Hip supports, fixed, pink, left		Size 2	8720245_L	105 <input type="checkbox"/>
	Adjustable, removeable hardware - HCPCS E1028				
	Required for each hip support			X87202	165 <input type="checkbox"/>
	HCPCS - E0956				
	Side support, fixed, right		Size 1	8720301_R	110 <input type="checkbox"/>
	Side support, fixed, left		Size 1	8720301_L	110 <input type="checkbox"/>
	Side support, fixed, right		Size 2	8720302_R	110 <input type="checkbox"/>
	Side support, fixed, left		Size 2	8720302_L	110 <input type="checkbox"/>
Medial Thigh Supports - E0957					
	Medial Thigh Support		Size 1	8720501	125 <input type="checkbox"/>
	Medial Thigh Support		Size 2	8720502	125 <input type="checkbox"/>
	Medial Thigh Support		Size 3	8720503	125 <input type="checkbox"/>
	Adjustable, removeable hardware - HCPCS E1028				
	Required			X87202	165 <input type="checkbox"/>

	Description	Color	Size	Part No.	Price
Accessories					
	HCPCS - E0955				
	Contoured Headrest cushion, blue		Size 1	8720811	195 <input type="checkbox"/>
	Contoured Headrest cushion, red		Size 1	8720812	195 <input type="checkbox"/>
	Contoured Headrest cushion, green		Size 1	8720813	195 <input type="checkbox"/>
	Contoured Headrest cushion, pink		Size 1	8720815	195 <input type="checkbox"/>
	Contoured Headrest cushion, blue		Size 2	8720821	195 <input type="checkbox"/>
	Contoured Headrest cushion, red		Size 2	8720822	195 <input type="checkbox"/>
	Contoured Headrest cushion, green		Size 2	8720823	195 <input type="checkbox"/>
	Contoured Headrest cushion, pink		Size 2	8720825	195 <input type="checkbox"/>
	Grip handle*		Size 1	8720401	195 <input type="checkbox"/>
	Grip handle*		Size 2	8720402	195 <input type="checkbox"/>
*Can not be used with 66-3375 or 66-4475 trays on next page					
	HCPCS - E0950				
	Tray, with edge		One size	X8776350-1	95 <input type="checkbox"/>
	HCPCS - E1028				
	Adjustable, removable hardware (Required)		One size	X8776350-2	165 <input type="checkbox"/>
	Tie-down attachments <i>For bus and other transport</i>		One size	8720901	200 <input type="checkbox"/>
	Canopy	Blue	Size 1	8720111	325 <input type="checkbox"/>
	Canopy	Red	Size 1	8720112	325 <input type="checkbox"/>
	Canopy	Green	Size 1	8720113	325 <input type="checkbox"/>
	Canopy	Pink	Size 1	8720115	325 <input type="checkbox"/>
	Canopy	Blue	Size 2	8720121	325 <input type="checkbox"/>
	Canopy	Red	Size 2	8720122	325 <input type="checkbox"/>
	Canopy	Green	Size 2	8720123	325 <input type="checkbox"/>
	Canopy	Pink	Size 2	8720125	325 <input type="checkbox"/>
	Rain cover - fits over canopy		Size 1 & 2	8720142	55 <input type="checkbox"/>
	Bunting Bag		Size 1	8720131	395 <input type="checkbox"/>
	Bunting Bag		Size 2	8720132	450 <input type="checkbox"/>
	Medical Essentials Carrier		One size	8720600	95 <input type="checkbox"/>
	Bookbag		Size 1	8720711	55 <input type="checkbox"/>
	Bookbag		Size 2	8720721	55 <input type="checkbox"/>
	HCPCS - K0108				
	Vent tray - 13" x 17"			8776290	450 <input type="checkbox"/>
	<i>Requires Central Wheel Lock Option</i>				

	Description	Size	Part No.	Price
HCPCS - E0955				
PAD STYLE - Requires bracket and fitting (see below)				
	Head support no. 1, Black Polyurethane (cover optional)		6171550	200 <input type="checkbox"/>
	Head support no. 2, Black Polyurethane (cover optional)		6172550	200 <input type="checkbox"/>
	Head support no. 3, Black Polyurethane (cover optional)		6173550	200 <input type="checkbox"/>
	Head support no. 4, Black Polyurethane (cover optional)		6174550	200 <input type="checkbox"/>
	Head support no. 8, (cover required), A = 3½", B = 6¼"		5031975	200 <input type="checkbox"/>
	Blue Comfort		15	65 <input type="checkbox"/>
	Black Decutex		83	65 <input type="checkbox"/>
	Anatomic head support*, Small - A = 3", B = 8"		5099001	250 <input type="checkbox"/>
	Anatomic head support*, Medium - A = 3", B = 10¼"		5099002	250 <input type="checkbox"/>
	Anatomic head support*, Large - A = 4¼", B = 13"		5099003	250 <input type="checkbox"/>
	*Includes Black Decutex Cover			
	Headband System (For Anatomic Head Support only)		99500	225 <input type="checkbox"/>
	Extra headband strap (For Anatomic Head Support only)		99400-5	55 <input type="checkbox"/>
	Adjustable Width Headrest, large laterals, without speakers**		99737XX-85	300 <input type="checkbox"/>
	Speakers for Adjustable Width Headrest, large laterals		X99717XX-85	95 <input type="checkbox"/>
	**Includes black Mesh cover			
HCPCS - E1028				
BRACKET STYLE				
	Swing-away Mounting Bracket - Height, Depth, Angle & Lateral Adjustable			
	Turtle bar system, short		98619-25	225 <input type="checkbox"/>
	Headrest fitting		8720850	50 <input type="checkbox"/>

	Description		Size	Part No.	Price
	The vests are available in colors: xx = 40: net, 60: black, 71: blue abc				
	Cross vest	K0108	size 0	89625-0xx	185 <input type="checkbox"/>
	Cross vest	K0108	size 1	89625-1xx	185 <input type="checkbox"/>
	Cross vest	K0108	size 2	89625-2xx	185 <input type="checkbox"/>
	Cross vest	K0108	size 3	89625-3xx	185 <input type="checkbox"/>
	Cross vest	K0108	size 4	89625-4xx	185 <input type="checkbox"/>
	Vest	K0108	size 0	89111-0xx	195 <input type="checkbox"/>
	Vest	K0108	size ¾	89111-075xx	195 <input type="checkbox"/>
	Vest	K0108	size 1	89111-1xx	195 <input type="checkbox"/>
	Vest	K0108	size 2	89111-2xx	195 <input type="checkbox"/>
	Vest	K0108	size 3	89111-3xx	195 <input type="checkbox"/>
	Vest	K0108	size 4	89111-4xx	195 <input type="checkbox"/>
	2-point Padded Hip Belt (9¾" end strap)	E0978		85424-1	95 <input type="checkbox"/>
	2-point Padded Hip Belt*		Size 2-T	SG85427-2	70 <input type="checkbox"/>
	<i>*1" Webbing, Blue padding</i>				
	Padded Pelvic Positioners				
	4-point Padded Positioner	K0108	size 1	SG85424-1	130 <input type="checkbox"/>
	4-point Padded Positioner	K0108	size 2	SG85424-2	130 <input type="checkbox"/>
	Neoprene Vest	K0108	size 1	89113-1	195 <input type="checkbox"/>
	Neoprene Vest	K0108	size 2	89113-2	195 <input type="checkbox"/>
	Neoprene Vest	K0108	size 3	89113-3	195 <input type="checkbox"/>
	Sternum Belt	K0108	size 0	SG85430-0	120 <input type="checkbox"/>
	Sternum Belt	K0108	size 1	SG85430-1	120 <input type="checkbox"/>
	Sternum Belt	K0108	size 2	SG85430-2	120 <input type="checkbox"/>
	Footstraps, plastic lock	E0951	one size	36-8596	35 <input type="checkbox"/>
	Footstraps, velcro	E0951	one size	36-8502	35 <input type="checkbox"/>
	Chest Belt, Upholstered	K0108	size 1	85428-1	265 <input type="checkbox"/>
	Chest Belt, Upholstered	K0108	size 2	85428-2	265 <input type="checkbox"/>
	Chest Belt, Upholstered	K0108	size 3	85428-3	265 <input type="checkbox"/>
	Chest Belt, Upholstered	K0108	size 4	85428-4	265 <input type="checkbox"/>

Description		Size	Part No.	Price		
Measurements	Size	A	B	C	D	E

vests and belts™

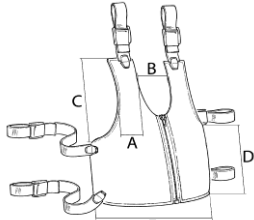
	Vest	Size 0	1¼"	2½"	5½"	3½"	11"
		Size ¾	1½"	2½"	5¾"	4¼"	12"
		Size 1	2¼"	2½"	7"	5"	13¼"
		Size 2	2½"	3½"	9¼"	5½"	15½"
		Size 3	2¾"	4¾"	11"	5¾"	18"
		Size 4	2¾"	6¾"	13¾"	7½"	19"

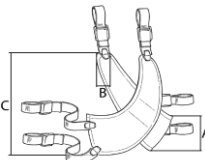
	Cross vest	Size 0	4¼"	½"	11"
		Size 1	5"	½"	12"
		Size 2	5½"	½"	12¾"
		Size 3	6¼"	4¾"	15¼"
		Size 4	7½"	6¾"	18¼"

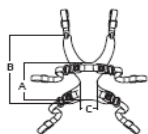
	Sternum Belt	Size 0	4"	14"	3"
		Size 1	6¼"	14"	3"
		Size 2	8¼"	18"	5½"

	Neoprene Vest	Size 1	7"	5½"	4"	4¾"
		Size 2	6½"	9"	6¾"	5¾"
		Size 3	11½"	7¾"	7"	6¾"

	2 pt. Hip belt, upholstered	Size 1	12¾"-14½"	2¼"	25¾"
		Size 2-T	10"	2¼"	24"

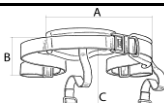
	4 pt. Pelvic Positioner	Size 1	12¾"-14½"	2¼"	19½"
		Size 2	16½"-20¼"	2¾"	19½"

	Footstraps	Size 1-4	w/buckle 23"	w/velcro 21"
---	-------------------	-----------------	--------------	--------------

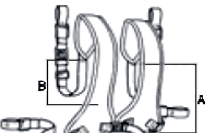
	Chest Belt	Size 1	11¼"	7½"	9¼"-12"
		Size 2	14"	10¼"	10¼"-12¾"
		Size 3	16½"	12½"	10¼"-12¾"
		Size 4	20¼"	16"	22¼"-14½"