

DORY

Technical Sheet



Dory is a seat designed for children from 4 to 12 years old who need postural support during recreational or didactic activities.

It is an extremely stable and robust seat with soft colored upholstery, pleasant to the touch. It can be combined with a large desk or with a tray table applicable to the armrests to favor the child's activities. Dory is a real active system designed to support children with special needs while they are playing or studying.

The chassis, adjustable in height, is covered with soft but compact padding adaptable to the child's body. It ensures a comfortable sitting position for long periods; the covering is extremely resistant to the stresses of use, such as scratching or tearing, or after repeated sanitization.

The armrests are adjustable in height and the chair can be supplied with a series of restraining supports such as thorax supports adjustable in height and width, restraining side supports for the pelvis adjustable in width or different kinds of belts for the trunk and / or the pelvis, to enable correct positioning. Feeling safe and properly supported, the child will be encouraged to engage himself in activities!



Dory equipped with footrest, trunk support, side supports, abductor, backrest extension and table.

Available colors.

..... Dimensional sheet

Seat

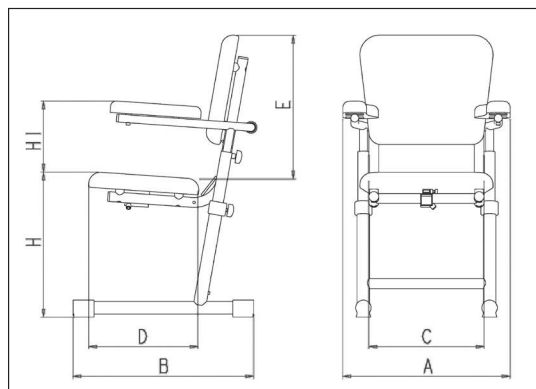

REFERENCES	UNIT 1	UNIT 2
A Width	44	49
B Length	46	52
C Seat width	32	36
D Seat depth	28	34
E Backrest height	38	45
H Height seat / ground	36 - 52	36 - 52
H1 Height seat / armrests	12 - 21	12 - 21
Child's age (years)	4 - 8	7 - 12
Child's height (cm)	104 - 126	121 - 150
Weight (Kg)	8	9,5
Max Load (Kg)	30	45

The measurements are in centimeters

Transparent tray

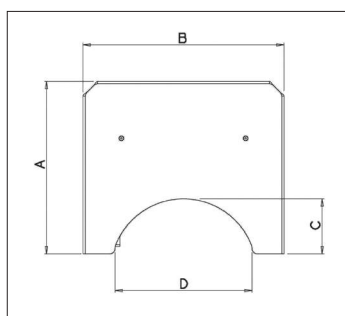

REFERENCES	SINGLE SIZE
A Depth	47
B Width	55
C Hollow depth	15
D Hollow width	37,5

The measurements are in centimeters

Desk

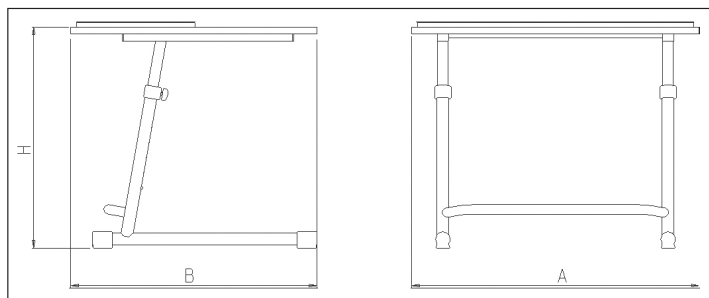

REFERENCES	SINGLE SIZE
A Width	76,5
B Length	65,5
H Seat height / ground	58,5 - 74,5
Weight (Kg)	12,5

The measurements are in centimeters

Upholstery colors



A=Blue



W=Violet



V=Green



H=Orange

Order form - Dory

Date _____

DISTRIBUTOR







Distributor _____







Shipping address (if different)

Dory - chair for children

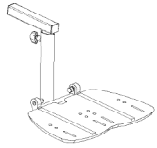
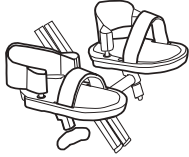
Basic configuration

- Chair for children who need a customized seat,
- padded seat and armrests, adjustable in height,
- backrest, seat and armrests in washable material.

Q.TY	CODE	DESCRIPTION	
	<input type="checkbox"/> 800001 Size 1	Chair for children who need a customized seat. The seat and the ergonomic padded armrests are adjustable in height. Seat and backrest upholstery are made of washable material. Dory can be supplied with numerous accessories to fulfil the child's needs	
	<input type="checkbox"/> 800002 Size 2	Upholstery colors <input type="checkbox"/> V= Green <input type="checkbox"/> H=Orange <input type="checkbox"/> W=Violet <input type="checkbox"/> A=Blue	
	<input type="checkbox"/> 800012 single size	Headrest/Backrest extension, adjustable in height Colors <input type="checkbox"/> V <input type="checkbox"/> H <input type="checkbox"/> W <input type="checkbox"/> A	
	<input type="checkbox"/> 800017 single size	Headrest adjustable in height Colors <input type="checkbox"/> V <input type="checkbox"/> H <input type="checkbox"/> W <input type="checkbox"/> A	
	<input type="checkbox"/> 800018 single size	Shapable headrest. Adjustable in height, depth, inclination and lateral Colors <input type="checkbox"/> V <input type="checkbox"/> H <input type="checkbox"/> W <input type="checkbox"/> A	
	<input type="checkbox"/> 800014 single size	Thorax side support adjustable in width and height, couple Colors <input type="checkbox"/> V <input type="checkbox"/> H <input type="checkbox"/> W <input type="checkbox"/> A	
	<input type="checkbox"/> 800013 single size	Pelvis side support separately adjustable in width Colors <input type="checkbox"/> V <input type="checkbox"/> H <input type="checkbox"/> W <input type="checkbox"/> A	
	<input type="checkbox"/> 800015 single size	Padded abductor adjustable in depth, removable Colors <input type="checkbox"/> V <input type="checkbox"/> H <input type="checkbox"/> W <input type="checkbox"/> A	

Q.TY	CODE	DESCRIPTION	
	<input type="checkbox"/> 800011 single size	Footrest adjustable in height and tilting (plantar and dorsi flexion) with feet straps	
	<input type="checkbox"/> 870121 size 1	Separated footrest independently adjustable in height, intra/extra rotation, dorsal/plantar flexion, and feet apart	
	<input type="checkbox"/> 870122 size 2		
	<input type="checkbox"/> 800016 single size	Pivoting wheels set, ø 40 with brake	-
	<input type="checkbox"/> 800021 single size	Trasparent try to insert in the seat armrest, foldaway	
	<input type="checkbox"/> 800020 single size	Desk, adjustable in height	
	<input type="checkbox"/> 800019 single size	Desk, adjustable in height and inclination	
	<input type="checkbox"/> 870331 size 1	Braces "Easy"	
	<input type="checkbox"/> 870332 size 2		
	<input type="checkbox"/> 870341 size 1	Vest "Easy"	
	<input type="checkbox"/> 870342 size 2		
	<input type="checkbox"/> 870351 size 1	45° pelvis belt, "Easy"	
	<input type="checkbox"/> 870352 size 2		