

Aria Wheels Srls

Registered Office_Via della Divisione Torino, 92 00143 Rome - Italy
Production Department_Via A.Volta 7/G 36030 Costabissara (VI) - Italy
TEL. / FAX +39 04441322533 | VAT id IT 12848301003 | email : info@ariawheels.com

NRIN
POSTURAL BACKRESTS

Aria® postural backrests, super-light, perfectly adaptable to the dorsolumbar segment. They assure a good containment without inhibiting the movement of bust and upper limbs.

The particular geometry of Aria® backrests and the use of innovative materials as the carbon fiber and aluminum ensure elasticity, resistance and a correct posture.

Aria Wheels has developed three solutions of backrests, depending on the needs:

Aria® rigid postural backrest, carbon fiber

Aria® semi-rigid moisture-wicking postural backrest, carbon fiber

Aria® postural backrest, aluminium

All are equipped with a series of holes which allow to adjust the height and can be mounted on rigid wheelchairs by the central clamp.

They are available in a range of different widths and heights.

The shells are provided with a 30mm high-density foam padding and its relative cover is in fire-resistant, moisture-wicking fabric.



In some countries the prices may change by 15%



CUSTOMER NAME: _____

DELIVERY ADDRESS: _____

DEALER: _____

ORDER NUMBER: _____

PRODUCT SPECIALIST: _____

ORDER DATE: _____

Before filling the boxes below regarding the sizes , please see the backrests technical scheme.
Aria Wheels Srls in order to avoid mistakes on the order form, suggests to contact a qualified person for taking the measurements. Aria Wheels can not make changes to the product after receiving the order form.

ARIA® POSTURAL BACKRESTS IN CARBON FIBRE AND ALUMINIUM

ARIA® RIGID POSTURAL
BACKREST IN CARBON FIBRE

BKRTR



€ 760,00

VAT and shipping
cost not included

ARIA® SEMI-RIGID
MOISTURE-WICKING POSTURAL
BACKREST IN CARBON FIBRE

BKRRTS



€ 820,00

VAT and shipping
cost not included

ARIA® POSTURAL BACKREST
ALUMINIUM

BKRRTA



€ 610,00

VAT and shipping
cost not included



ARIA® RIGID POSTURAL BACKREST CARBON FIBRE

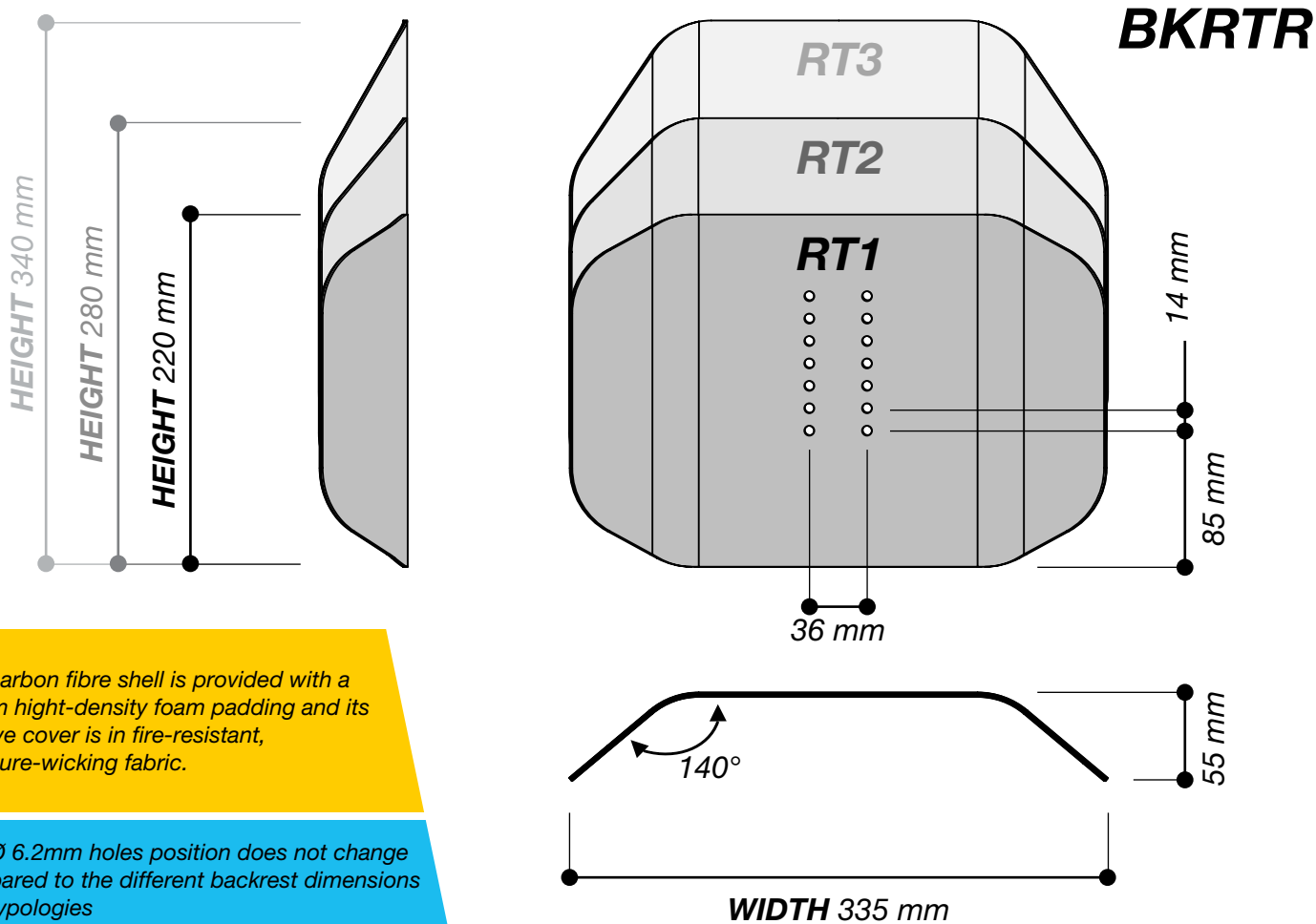

The carbon fibre shell is provided with a 30mm high-density foam padding and its relative cover is in fire-resistant, moisture-wicking fabric.

The Ø 6.2mm holes position does not change compared to the different backrest dimensions and typologies

CARBON FIBRE BACKREST RT2 WEIGHT (including padding) = ± 700 gr

Select your preference with a flag in the box

ARIA® RIGID POSTURAL BACKREST - CARBON FIBRE			
	CARB1T1	Size RT1	760,00 €
	CARB1T2	Size RT2	760,00 €
	CARB1T3	Size RT3	760,00 €

BACKREST SUPPORT - central clamp			
	ALCMT15	Backrest support for Aria 1.0 / Aria 2.0	STD
	ALCMT36	Backrest support for rigid frame wheelchair*	STD

* Indicates below the model of the wheelchair and the diameter of the pipe to fix the clamp - See the last page

Wheelchair model:

Diameter of the tube to mount the clamp

	19mm diameter		22mm diameter		25mm diameter
--	---------------	--	---------------	--	---------------



ARIA® RIGID POSTURAL BACKREST CARBON FIBRE

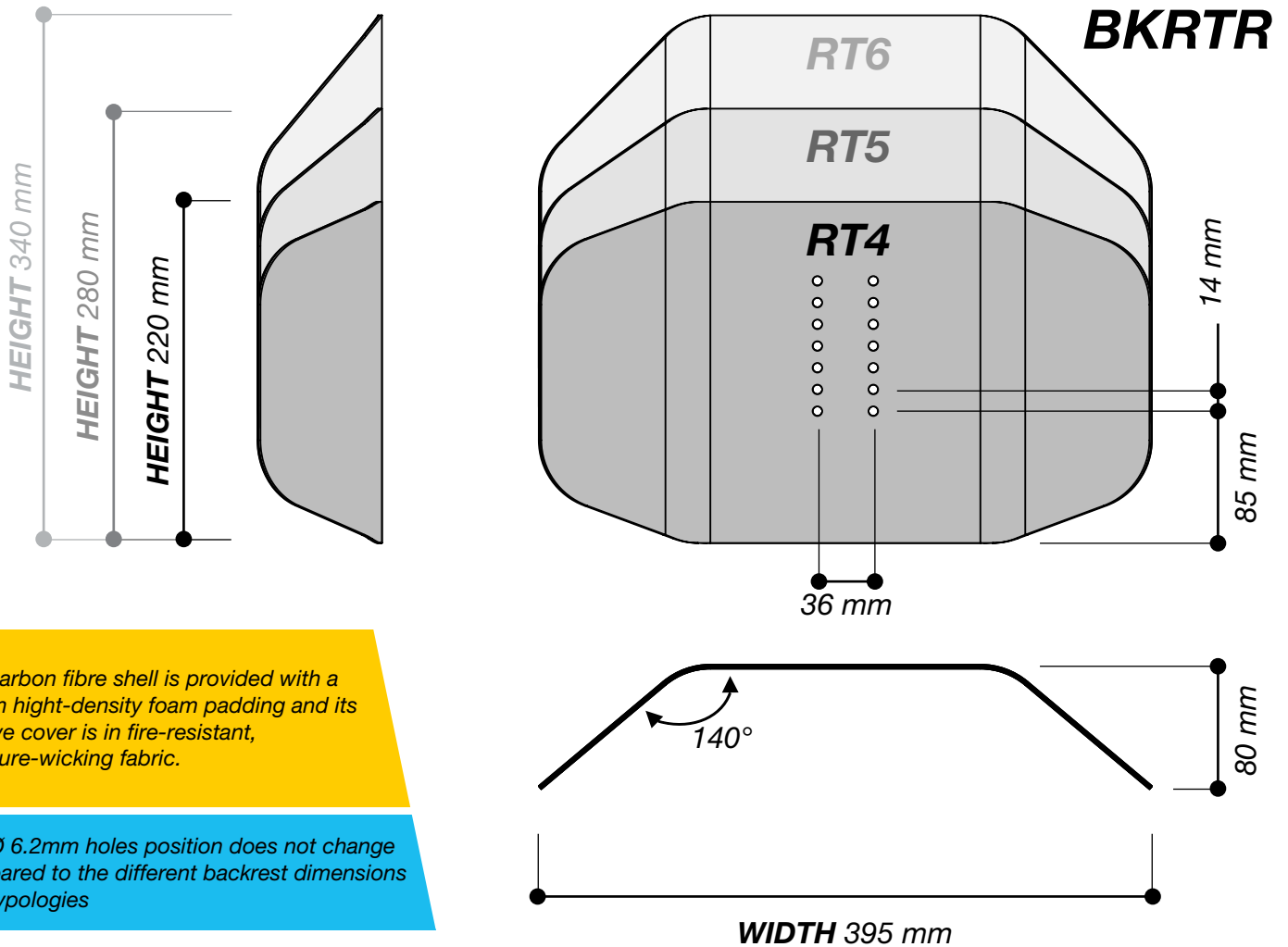

The carbon fibre shell is provided with a 30mm high-density foam padding and its relative cover is in fire-resistant, moisture-wicking fabric.

The Ø 6.2mm holes position does not change compared to the different backrest dimensions and typologies

Select your preference with a flag in the box

ARIA® RIGID POSTURAL BACKREST - CARBON FIBRE			
	CARB1T4	Size RT4	760,00 €
	CARB1T5	Size RT5	760,00 €
	CARB1T6	Size RT6	760,00 €

BACKREST SUPPORT - central clamp			
	ALCMT15	Backrest support for Aria 1.0 / Aria 2.0	STD
	ALCMT36	Backrest support for rigid frame wheelchair*	STD

* Indicates below the model of the wheelchair and the diameter of the pipe to fix the clamp - See the last page

Wheelchair model:

Diameter of the tube to mount the clamp

	19mm diameter		22mm diameter		25mm diameter
--	---------------	--	---------------	--	---------------



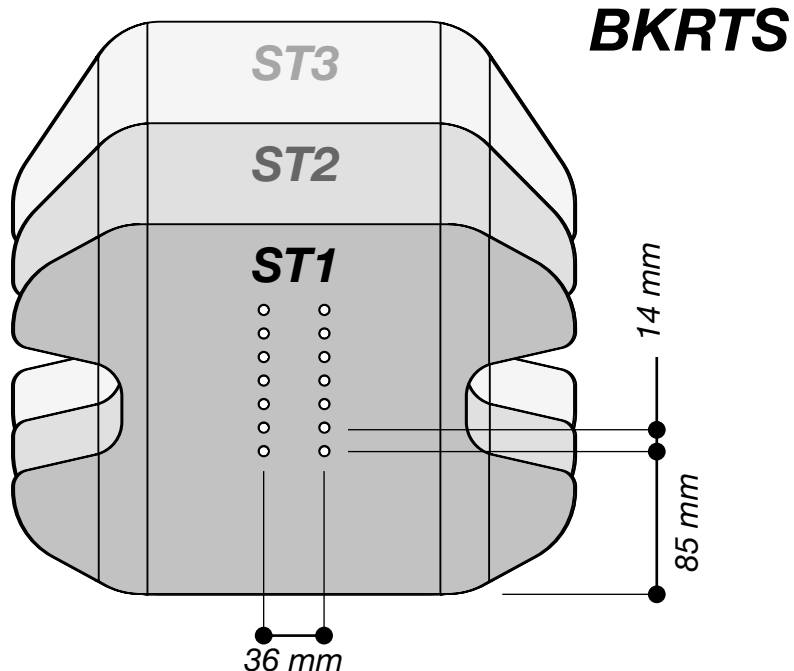
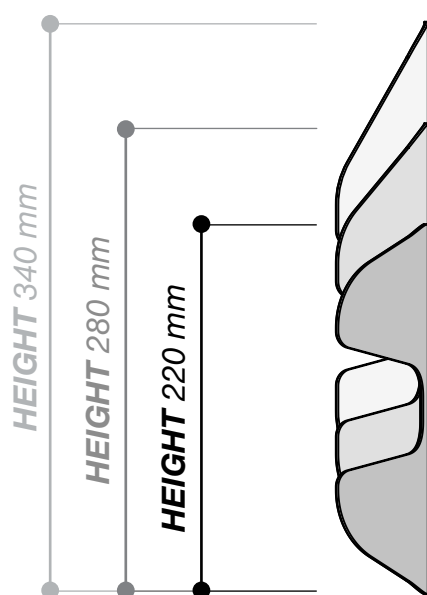

The carbon fibre shell is provided with a 30mm high-density foam padding and its relative cover is in fire-resistant, moisture-wicking fabric.

The Ø 6.2mm holes position does not change compared to the different backrest dimensions and typologies

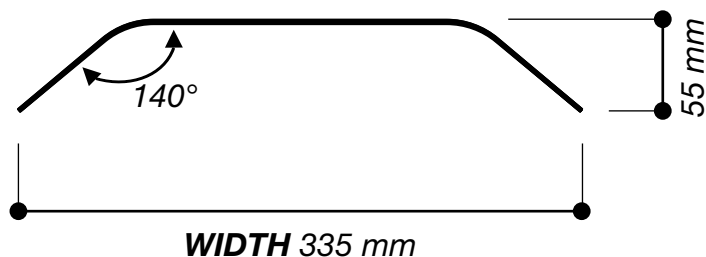

CARBON FIBRE BACKREST ST2 WEIGHT (including padding) = ± 650 gr

Select your preference with a flag in the box

ARIA® SEMI-RIGID MOISTURE-WICKING POSTURAL BACKREST - CARBON FIBRE			
CARB1.1	Size ST1		820,00 €
CARB1.2	Size ST2		820,00 €
CARB1.3	Size ST3		820,00 €

BACKREST SUPPORT - central clamp			
ALCMT15	Backrest support for Aria 1.0 / Aria 2.0	STD	
ALCMT36	Backrest support for rigid frame wheelchair*	STD	

* Indicates below the model of the wheelchair and the diameter of the pipe to fix the clamp - See the last page

Wheelchair model:

Diameter of the tube to mount the clamp

19mm diameter		22mm diameter		25mm diameter
---------------	--	---------------	--	---------------

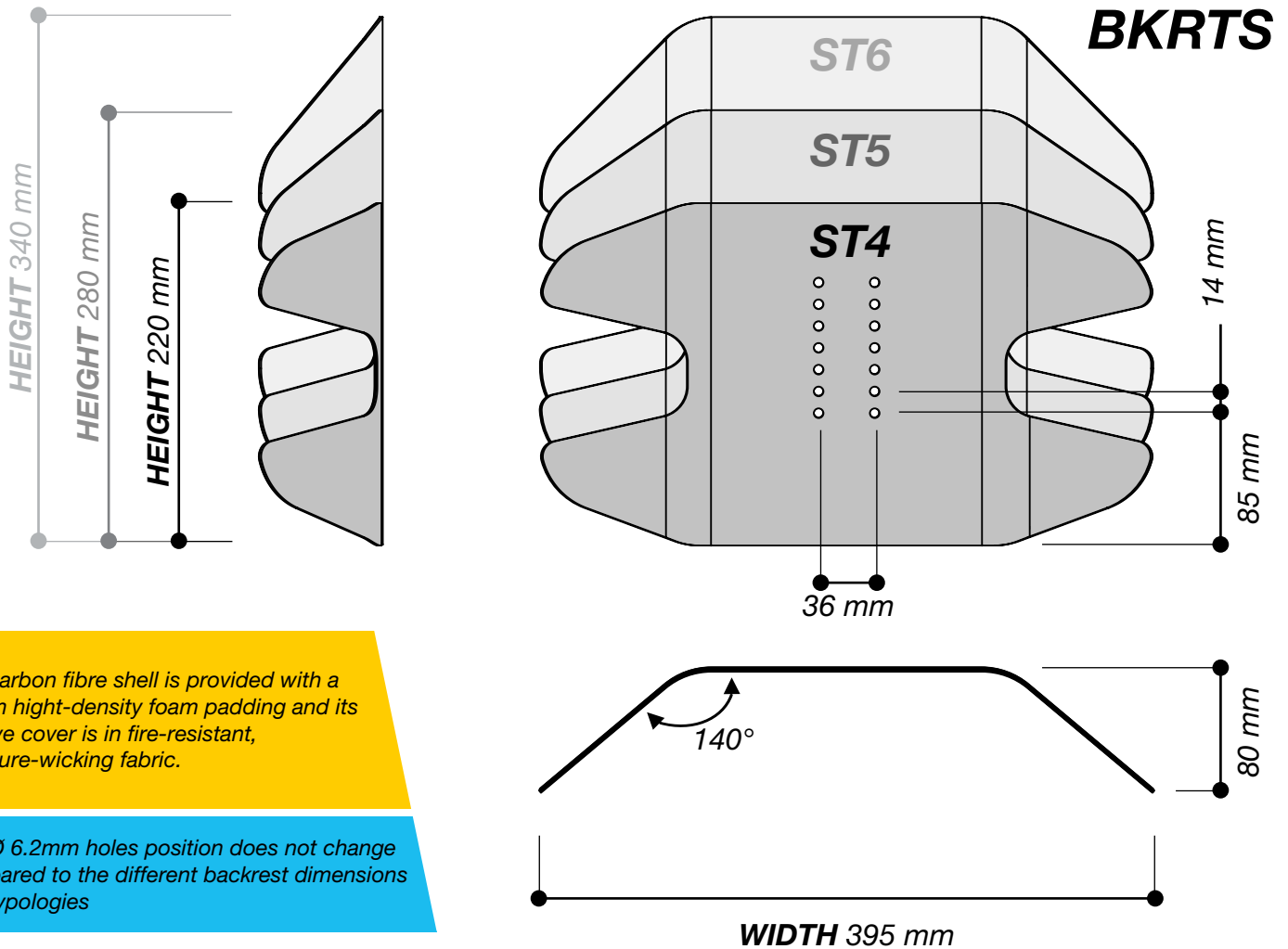

The carbon fibre shell is provided with a 30mm high-density foam padding and its relative cover is in fire-resistant, moisture-wicking fabric.

The Ø 6.2mm holes position does not change compared to the different backrest dimensions and typologies

Select your preference with a flag in the box

ARIA® SEMI-RIGID MOISTURE-WICKING POSTURAL BACKREST - CARBON FIBRE			
	CARB1.4	Size ST4	820,00 €
	CARB1.5	Size ST5	820,00 €
	CARB1.6	Size ST6	820,00 €

BACKREST SUPPORT - central clamp			
	ALCMT15	Backrest support for Aria 1.0 / Aria 2.0	STD
	ALCMT36	Backrest support for rigid frame wheelchair*	STD

* Indicates below the model of the wheelchair and the diameter of the pipe to fix the clamp - See the last page

Wheelchair model:

Diameter of the tube to mount the clamp

	19mm diameter		22mm diameter		25mm diameter
--	---------------	--	---------------	--	---------------

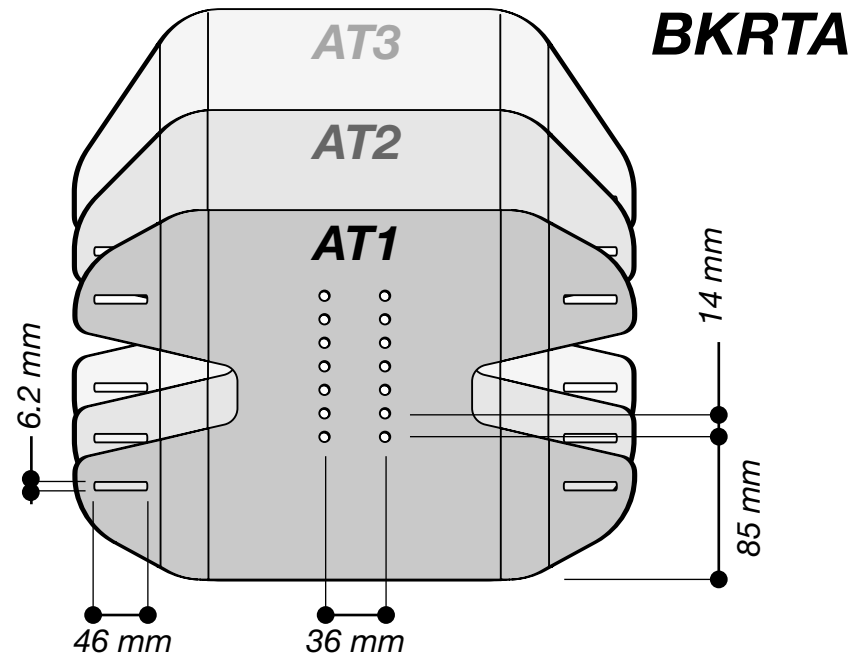
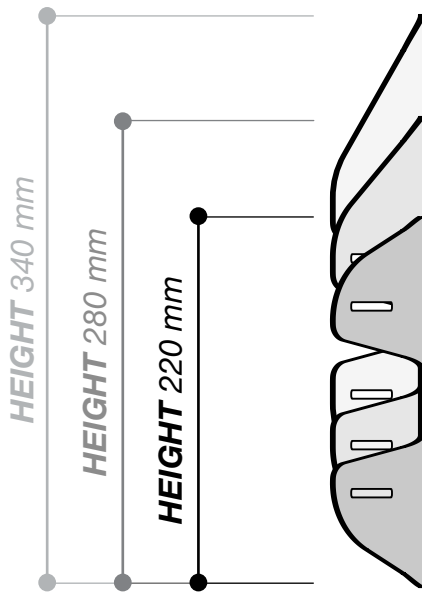

The aluminium shell is provided with a 30mm high-density foam padding and its relative cover is in fire-resistant, moisture-wicking fabric.

The Ø 6.2mm holes position does not change compared to the different backrest dimensions and typologies

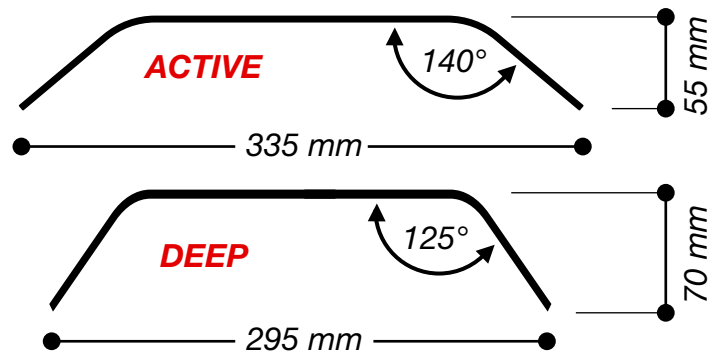

ALUMINIUM BACKREST AT2 WEIGHT (including padding) = ± 1000 gr

Select your preference with a flag in the box

ARIA® POSTURAL BACKREST - ALUMINIUM				
BKTAL1	Size AT1 active		Size AT1 deep	610,00 €
BKTAL2	Size AT2 active		Size AT2 deep	610,00 €
BKTAL3	Size AT3 active		Size AT3 deep	610,00 €

BACKREST SUPPORT - central clamp			
ALCMT15	Backrest support for Aria 1.0 / Aria 2.0		STD
ALCMT36	Backrest support for rigid frame wheelchair*		STD

* Indicates below the model of the wheelchair and the diameter of the pipe to fix the clamp - See the last page

Wheelchair model:

Diameter of the tube to mount the clamp

19mm diameter		22mm diameter		25mm diameter
---------------	--	---------------	--	---------------

ARIA® POSTURAL BACKREST ALUMINIUM

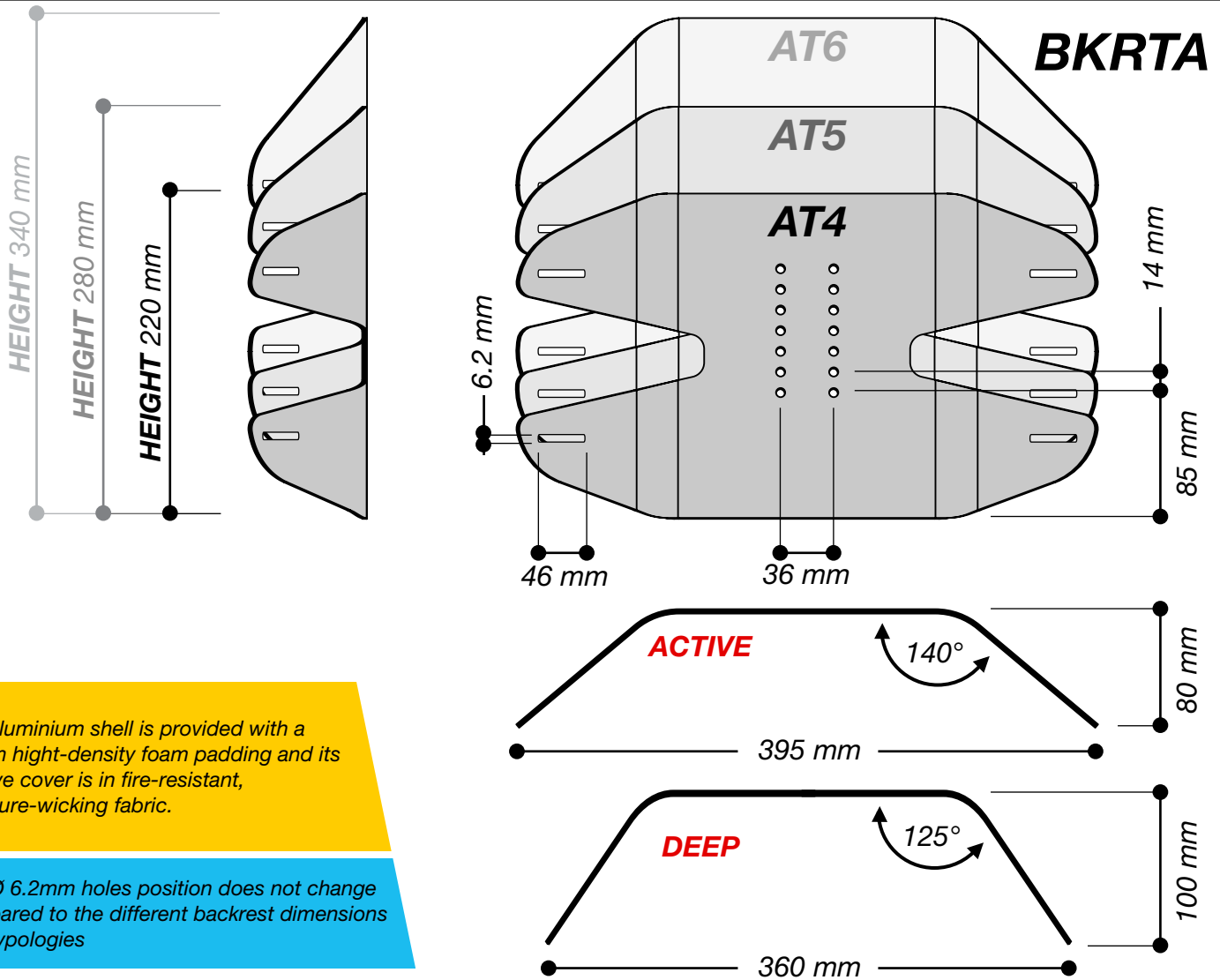

The aluminium shell is provided with a 30mm high-density foam padding and its relative cover is in fire-resistant, moisture-wicking fabric.

The Ø 6.2mm holes position does not change compared to the different backrest dimensions and typologies

Select your preference with a flag in the box

SCHIENALE IN ALLUMINIO					
	BKTAL4	Size AT4 active		Size AT4 deep	610,00 €
	BKTAL5	Size AT5 active		Size AT5 deep	610,00 €
	BKTAL6	Size AT6 active		Size AT6 deep	610,00 €

BACKREST SUPPORT - central clamp				
	ALCMT15	Backrest support for Aria 1.0 / Aria 2.0	STD	
	ALCMT36	Backrest support for rigid frame wheelchair*	STD	

* Indicates below the model of the wheelchair and the diameter of the pipe to fix the clamp - See the last page

Wheelchair model:

Diameter of the tube to mount the clamp

	19mm diameter		22mm diameter		25mm diameter
--	---------------	--	---------------	--	---------------



TECHNICAL SCHEME FOR ARIA® WHEELCHAIRS

BRH with T3 or T6 shell from 375 to 420 mm
 BRH with T2 or T5 shell from 315 to 360 mm
 BRH with T1 or T4 shell from 240 to 300 mm

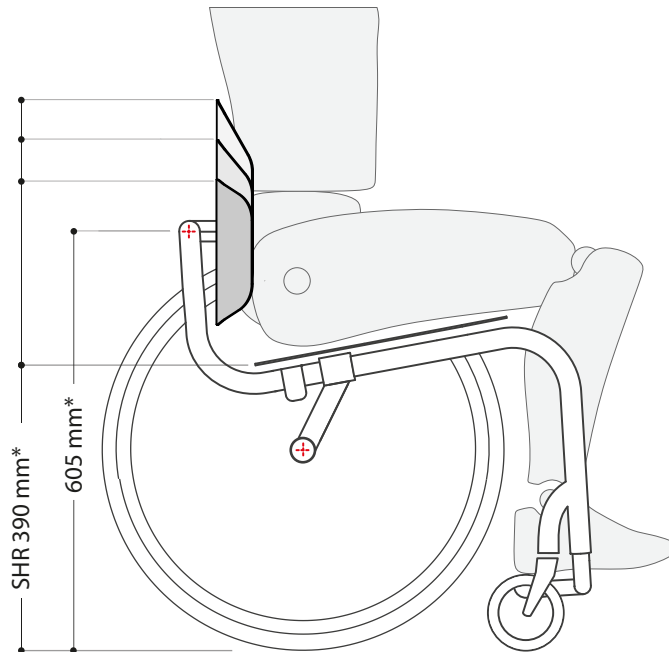
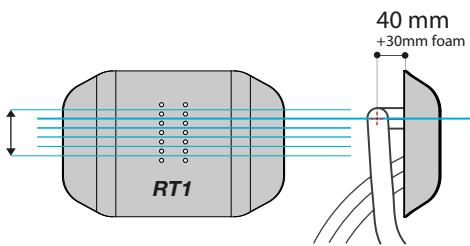

* considered with 24" rear wheels

BACKREST SUPPORT FOR RIGID FRAME WHEELCHAIR (ALCMT36)



The backrest height, angle and depth are adjustable thanks to the clamp.

The clamp can be mounted on tubes 25mm, 22mm and 19mm diameter

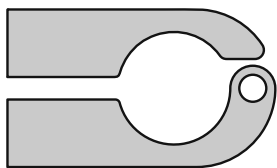

∅ 25mm

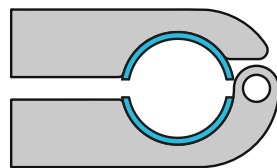

∅ 22mm

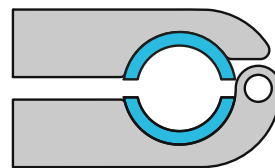

∅ 19mm

FOR SPECIAL NEEDS, PLEASE NOTE THE REQUESTS BELOW: