

# R82 Multi Frame

## CAD Retail Price List/ Order Form



Account #: \_\_\_\_\_

Purchase Order No.: \_\_\_\_\_

Date: \_\_\_\_\_

Contact: \_\_\_\_\_

Mark For: \_\_\_\_\_

Bill To:	Ship To:
Address:	Address:
City/State/Zip:	
Phone:	City/State/Zip:
Email	Phone:

### Multi Frame Standard Features:

- 3 Sizes
- Change of Seat to Floor Height
- Angle Adjustable Push Brace
- Built-in Tilt-in-Space 0° to 30°
- Wheel Locks
- Anti-Tips, Swing-Away



- Size 1
- Size 2
- Size 3
  
- Silver
  
- 12½" Pneumatic Rear, Black
- 22" Pneumatic Rear, Grey
- 12½" Solid Rear Wheels, Black
- 22" Solid Rear Wheels, Grey
  
- Wheel locks - *No Charge*
- Drum Brake for 12½" - *Upcharge*
- Drum brake for 22" - *Upcharge*
  
- 7" x 2" Pneumatic Caster Tires
- 7" x 2" Solid Caster Tires

97 X 1 X X X 1 0

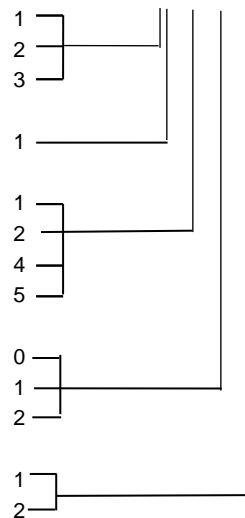

- Wheelchair Frame, 12½" Rear Wheels
- Wheelchair Frame, 22" Rear Wheels
  
- Drum Brake, 12½" or 22" Rear Wheels

**CAD Price**

\$3,305

\$3,679

\$355

**Transit Option**

- Transit (A)

**Size**

One Size



**CAD Price**

\$249

**Part No.**

970905

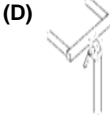

		<b>Foot &amp; Leg Positioning</b>	<b>Size</b>	<b>CAD Price</b>	<b>Part No.</b>
(A)		<input type="checkbox"/> Multi-Adjustable Foot Supports (6" to 10½") (A)		\$505	8910852-1
		<input type="checkbox"/> Multi-Adjustable Foot Supports (6" to 14½") (A)		\$505	8910852-2
(B)		<input type="checkbox"/> Multi-Adjustable Foot Supports (6" to 17") (A)		\$505	8910852-3
		<input type="checkbox"/> Footplate, Angle & Height Adjustable (12") (B)	1	\$143	95145-1
(C)		<input type="checkbox"/> Footplate, Angle & Height Adj. w/4" Mounting Fitting (C)	2	\$143	85145-2
		<input type="checkbox"/> Footplate, Angle & Height Adj. w/4" Mounting Fitting (C)	2	\$143	95145-2
(D)		<input type="checkbox"/> Footplate, Angle & Height Adj. w/4" Mounting Fitting (C)	3	\$143	95145-3
		<input type="checkbox"/> Footplate, Angle & Height Adj. w/4" Mounting Fitting (C)	4	\$143	95145-4
		<input type="checkbox"/> Footplate Mounting Bar (Required w/ Footplate) (D)	6" - 10½"	\$181	8910821-1
		<input type="checkbox"/> Footplate Mounting Bar (Required w/ Footplate) (D)	6" - 14½"	\$181	8910821-2
		<input type="checkbox"/> Footplate Mounting Bar (Required w/ Footplate) (D)	6" - 17"	\$181	8910821-3

		<b>Frame Options</b>	<b>Size</b>	<b>CAD Price</b>	<b>Part No.</b>
(A)		<input type="checkbox"/> Spoke Protectors (A)	22"	\$187	970922

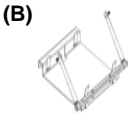
		<b>Accessories</b>	<b>Size</b>	<b>CAD Price</b>	<b>Part No.</b>
(A)		<input type="checkbox"/> Anti-Tips (Required)	One Size	\$181	X970957
		<input type="checkbox"/> Adapter for x:panda sz 1, 2, 3 (A)*		\$218	8911610-98
(B)		<input type="checkbox"/> Adapter for x:panda sz 4 (A)^		\$218	8911610-99
		<input type="checkbox"/> Vent Tray (12" x 12" x 2") (B)	2, 3	\$561	970815
		<b>(A)* Required with x:panda sz 1, 2, 3</b>			
		<b>(A)^ Required with Multiframe sz 3</b>			

**For shipping rates, please call 1-844-876-6245**  
 PO Box 1739 Matthews, NC 28106 • 1-844-876-6245 • Fax: 704-882-0751  
 Prices in USD & is subject to change without notice  
 Effective: 6/16/2017

**Configuration**

- Multi Frame
- Foot Support
- Adapter
- Transport Fittings



- A (Back Height) \_\_\_\_\_
- B (Arm Height) \_\_\_\_\_
- C (Lower Leg Length) \_\_\_\_\_
- D (Seat Depth) \_\_\_\_\_
- E (Chest Width) \_\_\_\_\_
- F (Seat Width) \_\_\_\_\_
- G (Height-Seat to Top of Head) \_\_\_\_\_
- H (Shoulder Width) \_\_\_\_\_
- Age \_\_\_\_\_
- Weight \_\_\_\_\_

**Measurements**

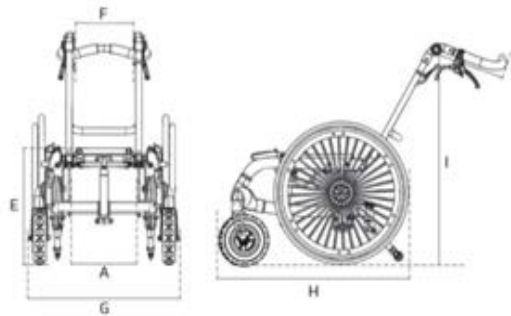

**Multi Frame**

	<b>Size 1 Inches</b>	<b>Size 2 Inches</b>	<b>Size 3 Inches</b>
Width, Inside (A)	13¼"	15¼"	17¼"
Height Floor to Basic Plate (E) (Top/Mid/Bottom Pos.)	15½"/16½"/17¼"	15½"/16½"/17¼"	15½"/16½"/17¼"
Back Width, Inside (F)	9½"	11½"	13½"
Total Width 12½" (G)	23"	25"	27"
Total Width 22" (G)	23"	25"	27"
Distance Between Wheels with Drum Brake (G1)	16¾"	18¾"	20½"
Distance Between Wheels without Drum Brake (G1)	17¼"	19"	21"
Length of Frame 12½" (H)	25"	25"	27"
Length of Frame 22" (H1)	29¼"	29¼"	31¼"
Height Push Brace (I)	34¼" - 38¼"	34¼" - 38¼"	34¼" - 38¼"
Height Push Brace 30° (I1)	33½"	33½"	33½"
Push Brace Length (I2)	8¾"	8¾"	8¾"
Seat Angling	0 - 30°/35°/40°	0 - 30°/35°/40°	0 - 30°/35°/40°
Height Folded, without Back Wheels (Mid Position)	15½"	15½"	15½"
Height Folded, with 12½" Back Wheels (Mid Position)	18¼"	18¼"	18¼"
Height Folded, with 22" Back Wheel (Mid Position)	22"	22"	22"
Length Folded, without Back Wheel	27¼"	27¼"	29¼"
Length Folded, with 12½" Back Wheels	28½"	28½"	30½"
Length Folded, with 22" Back Wheels	33¼"	33¼"	35"
Max Load (User/Seat/Accessories)	220 lbs.	220 lbs.	220 lbs.
Max Load at Transportation (User/Seat/Accessories)	220 lbs.	220 lbs.	220 lbs.
Weight (12½" Air Wheels, Solid Front Wheels)	28.6 lbs.	28.6 lbs.	28.6 lbs.
Weight (22" Air Wheels, Air Front Wheels)	30.8 lbs.	30.8 lbs.	30.8 lbs.